

RADIO'S LIVEST MAGAZINE

OVER 175 ILLUSTRATIONS

Radio-Craft

★

HUGO GERNSEBACK EDITOR

SPECIAL
RADIO SET
BUILDERS
NUMBER

September
25 Cents

In United States
and Canada



See Page 138

Business Problems of the Service Man — New Directional-Loop Boat Set
A Battery Portable — Beginner's Set — 1-Tube Interoffice Communicator

OVER 50,000 RADIO MEN READ RADIO-CRAFT MONTHLY

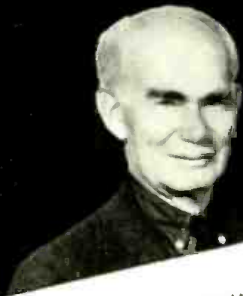

"YOUR NEW MODEL 502 HAS ALMOST SUPER-HUMAN ABILITY!"

SIGNED

Lee de Forest

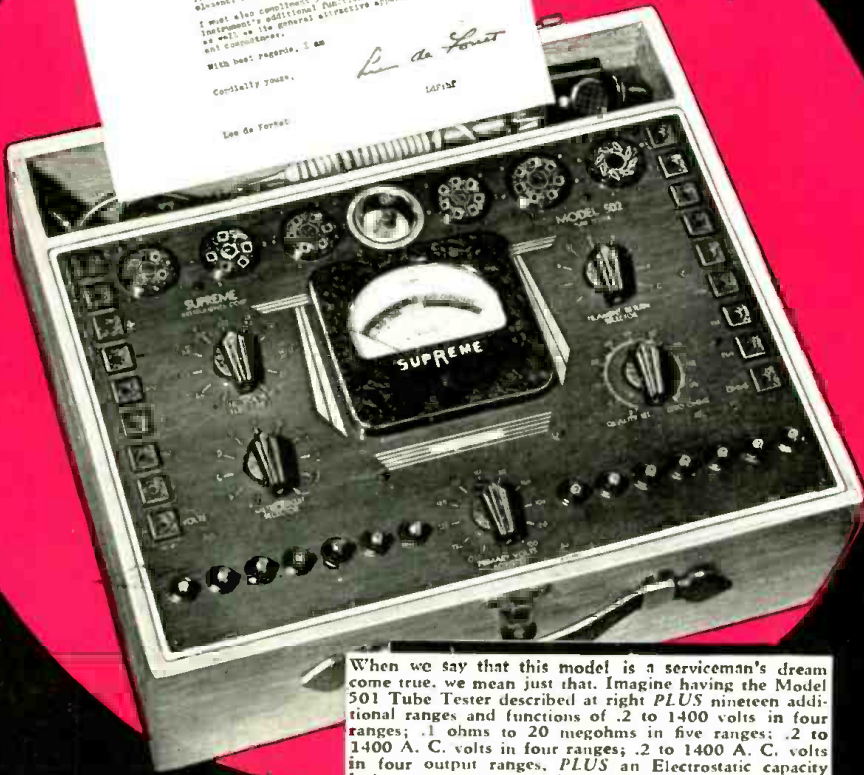
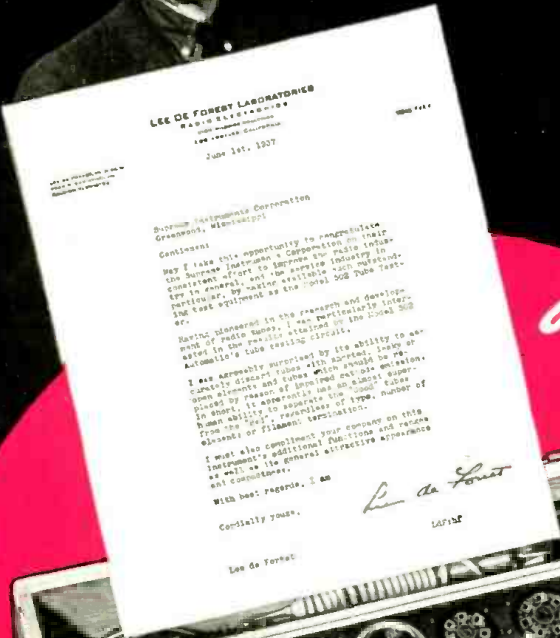

When we say that this model is a serviceman's dream come true, we mean just that. Imagine having the Model 501 Tube Tester described at right PLUS nineteen additional ranges and functions of .2 to 1400 volts in four ranges; .1 ohms to 20 megohms in five ranges; .2 to 1400 A. C. volts in four ranges; .2 to 1400 A. C. volts in four output ranges; PLUS an Electrostatic capacity leakage test on a neon bulb and PLUS an Electrolytic filter capacity leakage test on a "Good-Bad" English reading scale. A complete, quality tube tester and set tester in a space 10½" x 14½" x 5", weighing only 16 lbs. at this new low price.

Dealer's Net Cash Price Model 502 \$49.95
Or, \$5.50 cash and 10 monthly payments of \$4.95

Everybody is talking about the new 1938 SUPREME instruments — the HIT of the Chicago Radio Show!

Both servicemen and jobbers alike are loud in their praise of these smaller, lighter and more compact instruments!

Each designed around SUPREME'S new flush-panel meter, built to new high standards of precision by Westinghouse. Beautifully modeled in antique Bronze panels with Golden Oak carrying cases. Perfectly engineered, these SUPREME instruments are destined to sweep the service industry like wild fire, and bring you a complete new conception of operating ease and accurate results that COUNT!

Never before has so much instrument been offered for so little money. And remember, these new SUPREME instruments are all available on the S. I. C. Payment Plan — the world's easiest installment terms!

SOLD ON SUPREME S.I.C. TERMS—THE WORLD'S EASIEST INSTALLMENT TERMS

SUPREME INSTRUMENTS CORP.
GREENWOOD, MISSISSIPPI

Export Dept., Associated Exporters Co., 145 W. 45th St., New York City
Cable Address LDPREH, New York

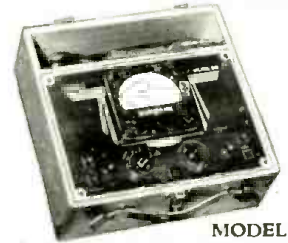

MODEL 541

Here is the sweetest and fastest little Set Tester ever offered a serviceman at any price. Measuring only 7¼x10¼x4½" and weighing but 9 pounds, 20 ranges and functions are at your finger tips on a single selector switch.

Here you have .2 to 1400 A. C. volts in four ranges; .2 to 1400 D. C. volts in four ranges; .2 to 1400 A. C. volts in four output ranges; .1 ohm to 20 megohms in five ranges (all self-contained)—and look at the price!

Dealer's Net Cash Price \$26.95
Or, \$4.00 cash and 7 monthly payments of \$3.67

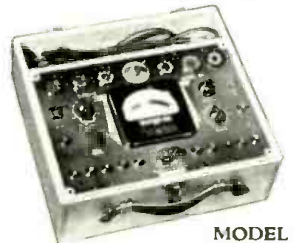

MODEL 501

Test your customers' tubes more accurately—sell more tubes! That's SUPREME'S new Electro-conductance tube tester. This excellently engineered unit tests tubes for (1) Inter-element leakage between any two elements, (2) open test in any element, (3) short check between any two elements, (4) quality test of complete tube and (5) in the case of tubes having two or more sections, separate sectional quality tests. 5 TESTS ON EVERY TUBE!

Here is value unsurpassed! Trick tubes won't bother you — new tubes won't bother you. If you don't know all about SUPREME'S exclusive "floating filament" tube testing circuit be sure to write today.

Dealer's Net Cash Price \$36.95
Or, \$4.00 cash and 10 monthly payments of \$3.66

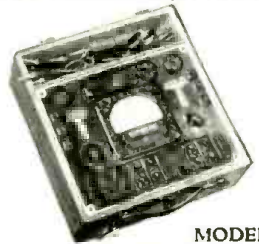

MODEL 551

To the serviceman who appreciates the truly time saving ability of SUPREME'S "Free Reference Point" system of analysis, we say "Buy the Model 551 Analyzer!" Use it as a multimeter—or use it as an analyzer! For here you have all the point-to-point functions and ranges of the Model 541 Set Tester PLUS the ability to make all resistance, voltage or current measurements between any two tube elements, or between any tube element and ground or chassis. Why "Get out and get under" the radio chassis?

Instead, using the Model 551, the serviceman literally spreads out the radio receiver's circuit on the analyzer panel, eliminating costly delays in physically breaking each individual circuit for current measurements, or fishing around underneath the chassis for point-to-point tests.

Dealer's Net Cash Price \$38.95
Or, \$4.25 cash and 10 monthly payments of \$3.86

HE THOUGHT HE WAS LICKED—THEN A TIP GOT BILL A GOOD JOB!

MY RAISE DIDN'T COME THROUGH MARY—I MIGHT AS WELL GIVE UP. IT ALL LOOKS SO HOPELESS.

IT ISN'T HOPELESS EITHER BILL. WHY DON'T YOU TRY A NEW FIELD LIKE RADIO?

TOM GREEN WENT INTO RADIO AND HE'S MAKING GOOD MONEY, TOO. I'LL SEE HIM RIGHT AWAY.

BILL, JUST MAILING THAT COUPON GAVE ME A QUICK START TO SUCCESS IN RADIO. MAIL THIS ONE TONIGHT

TOM'S RIGHT—AN UNTRAINED MAN HASN'T A CHANCE. I'M GOING TO TRAIN FOR RADIO TOO. IT'S TODAY'S FIELD OF GOOD PAY OPPORTUNITIES

U.S. MAIL

TRAINING FOR RADIO IS EASY AND I'M GETTING ALONG FAST--

SOON I CAN GET A JOB SERVICING SETS— OR IN A BROADCASTING STATION

OR INSTALLING LOUD SPEAKER SYSTEMS

THERE'S NO END TO THE GOOD JOBS FOR THE TRAINED RADIO MAN

YOU SURE KNOW RADIO—MY SET NEVER SOUNDED BETTER

THAT'S \$15 I'VE MADE THIS WEEK IN SPARE TIME

THANKS!

I HAVE A GOOD FULL TIME RADIO JOB NOW-- AND A BRIGHT FUTURE AHEAD IN RADIO

OH BILL, IT'S WONDERFUL YOU'VE GONE AHEAD SO FAST IN RADIO.

I'LL TRAIN YOU AT HOME In Your Spare Time For A GOOD RADIO JOB

HERE'S PROOF THAT MY TRAINING PAYS



N.R.I. Training Increases Yearly Salary \$1,200

"Since securing my operator's license through N. R. I. Training, I've been regularly employed and am now with W.D.O.D. My salary has increased \$1,200 in Radio."
—JULIUS C. VESSELLS, Station W.D.O.D., Chattanooga, Tenn.



Earning \$10 to \$25 a Week in Spare Time

"I am making from \$10 to \$25 a week in spare time while still holding my regular job as a machinist. I owe my success to N. R. I."
—WM. F. RUPP, 203 W. Front St., West Conshohocken, Pa.

Lesson on Radio Servicing Tips—FREE

I'll prove that my Training gives practical money-making information, that it is easy to understand—that it is just what you need to master Radio. My sample lesson text, "Radio Receiver Troubles—Their Cause and Remedy" covers a long list of radio receiver troubles in A.C., D.C., battery, universal, auto. T. R. F., super-heterodyne, all-wave, and other types of sets. And a cross reference system gives you the probable cause and a quick way to locate and remedy these set troubles. A special section is devoted to receiver check-up, alignment, balancing, neutralizing and testing. Get this lesson Free. No obligation. Just mail coupon.



Many Radio Experts Make \$30, \$50, \$75 a Week
Do you want to make more money? Broadcasting stations employ engineers, operators, station managers and pay up to \$5,000 a year. Spare time Radio set servicing pays as much as \$200 to \$500 a year—full time servicing pays as much as \$30, \$50, \$75 a week. Many Radio Experts operate full or part time Radio businesses. Radio manufacturers and jobbers employ testers, inspectors, foremen, engineers, servicemen, paying up to \$6,000 a year. Radio operators on ships get good pay, see the world. Automobile, police, aviation, commercial Radio, loud speaker systems offer good opportunities now and for the future. Television promises many good jobs soon. Men I trained have good jobs in these branches of Radio.

Many Make \$5, \$10, \$15 a Week Extra in Spare Time While Learning

Almost every neighborhood needs a good spare time serviceman. The day you enroll I start sending you Extra Money Job Sheets. They show you how to do Radio repair jobs; how to cash in quickly. Throughout your training I send plans and ideas that made good spare time money for hundreds of fellows. I send special Radio equipment, give you practical experience—show you how to conduct experiments, build circuits, illustrating important Radio principles.

Find Out What Radio Offers You

Mail the coupon now for "Rich Rewards in Radio." It's free to any fellow over 16 years old. It points out Radio's spare time and full time opportunities, also those coming in Television; tells about my Training in Radio and Television; shows you letters from men I trained, telling what they are doing and earning; shows my Money Back Agreement. MAIL COUPON in an envelope, or paste on a postcard—NOW!

J. E. SMITH, President, Dept. 7JX
National Radio Institute, Washington, D. C.

J. E. SMITH, President, Dept. 7JX
National Radio Institute, Washington, D. C.

Dear Mr. Smith: Without obligation, send me the Sample Lesson and your free book about the spare time and full time Radio opportunities, and how I can train for them at home in spare time. (Please write plainly.)

NAME AGE.....

ADDRESS

CITY STATE..... 14X-1



J. E. SMITH, President, National Radio Institute. Established 1914. The man who has directed the home study training of more men for Radio than any other man in America.



Please Say That You Saw It in RADIO-CRAFT



HUGO GERNSBACK, Editor-in-Chief
 N. H. LESSEM Associate Editor C. P. MASON Associate Editor
 R. D. WASHBURN, Managing Editor

CONTENTS—SEPT. 1937, ISSUE

Volume IX Number 3

Editorial: What's New in Radio?.....Hugo Gernsback 133
 The Radio Month in Review..... 134
 How to Make the RADIO-CRAFT Super-DeLuxe 30-Tube Set—Part II, The All-Wave R.F. Tuner..... 136
 Radio and P.A. for Touring Cyclists..... 138
 "Button Tuning" Is Newest Convenience..... 138
 A Pocket-Size Crystal Set for BeginnersN. H. Lessem 139
 International Radio Review..... 140
 Cosmic Rays—Shortest Wavelength in the WorldL. S. Fox 141
 How to Make "The Seafarer" Loop-Type Boat Radio Set—Part I.....Raymond P. Adams 142
 The ABC of Electrolytic CondensersPaul McKnight Deeley 144
 This "Power Level" Checker Makes Dynamic Tube Tests.....H. Harrison 144
 Business Problems of the Service Man.....Jack Grand 145
 New Tubes for the Radio Experimenter—Part IR. D. Washburne 146
 The "Cold Cathode" Gaseous RectifierH. F. Argento 147
 The "H" Pad Offers Constant Impedance to the Power Source.....W. H. Fritz 147
 The "Open Road 3" Battery Portable Radio ReceiverH. G. McEntee 148
 An Easily-Built Short-Wave Superhet. "5"D. L. Warner 150
 A New Short-Wave Converter for Car Radio SetsC. O. Peek 150
 Application of Feedback to a Beam Power AmplifierJ. B. Nichols 151

An Inexpensive Dual Recording and P.A. SystemM. N. Beitman 151
 Operating Notes 152
 Servicing Questions and Answers..... 153
 How to Make an A.C.-D.C. Interphone Using Only 1 Tube!.....Arthur Blumenfeld 154
 The Latest Radio Equipment..... 156
 Compensation of Amplifier Response for Local NeedsS. Ruttenberg 158
 Hi-Voltage Power from a Storage BatteryLouis Gancher 158
 A 120-Watt "Cathode-Drive" Hi-Fi AmplifierA. C. Shaney 159
 New Radio Sets for 1937-'38..... 160
 RADIO SERVICE DATA SHEETS:
 Nos. 209 and 210—Sentinal—Erla Models 76-A and AC 162
 No. 211—Dictograph A.C.-D.C. "Silent Radio" Model 91134 Series..... 166
 Radio Wittiquiz..... 164
 ORSMA Members' Forum..... 164
 Readers' Department 164

**OCTOBER RADIO-CRAFT—
 NEW SPECIAL
 TEST EQUIPMENT NUMBER!**

The pressing demand for up-to-the-second information on the latest types of test equipment has induced RADIO-CRAFT to feature in the forthcoming October issue the interests of this particular field. The service and test requirements of modern radio and electronic apparatus have brought forth many important developments in test equipment about which every radio man should know if his work is to be accurate, speedy and profitable.

Put in your order today with your local newsdealer for your copy of October RADIO-CRAFT—the special TEST EQUIPMENT NUMBER!

Published by Radcraft Publications, Inc. Publication office: 29 Worthington Street, Springfield, Mass. Editorial and Advertising Offices: 99 Hudson Street, New York City. Chicago Advertising Office: L. F. McClure, 919 North Michigan Avenue, Chicago, Ill. Western Advertising Office: Loyd B. Chappell, 530 West Sixth St., Los Angeles, Calif.

Foreign Agents:
 London—Gorrings American News Agency, 9A Green St., Leicester Square, W. C. 2, England.
 Paris—Messageries Dawson, 4 Rue Faubourg, Poissonniere, France.
 Melbourne—McGill's Agency, 179 Elizabeth St., Australia.
 Dunedin—James Johnston, Ltd., New Zealand.

RADIO-CRAFT is published monthly, on the first of the month preceding that of date; subscription price is \$2.50 per year in U. S. and Canada. (In foreign countries, \$3.00 a year to cover additional postage.) Entered at the post office at Springfield as second-class matter under the act of March 3, 1879.

Text and illustrations of this magazine are copyright and must not be reproduced without permission of the copyright owners.

Copyright 1937. Radcraft Publications, Inc.

The New 1938 ALLIED Catalog is Ready

EVERYTHING IN RADIO at Lowest Prices!

FOR DEALERS
SERVICE MEN • AMATEURS
RADIO BUILDERS • SOUND MEN

More than 12,000 PARTS



In ONE book—more than 12,000 exact duplicate and replacement parts—clearly indexed—specially arranged for split-second reference—saves hours of time over ordinary catalogs! No matter whether it's "hard-to-get" or everyday, it's in the ALLIED Catalog!

32 New KITS



A new, enlarged section for Radio Builders! Kits of every type, from a Beginners' 1 Tube Set to a 14 Tube All-Wave Superhet. We can supply matched kits for building any circuit in any radio publication. Write to us for Free Parts Lists. ALLIED is Radio Parts Headquarters for Radio Builders everywhere!



61 Amazing New RADIOS



New 1938 KNIGHT Radios with astounding new features—push-button tuning, AFC, Beam Power Tubes, Armchair and plastic cabinets, etc.! All-Wave and Dual-Wave—5 to 16 tubes—for AC, AC-DC, 6 Volt, 32 Volt, Battery and Auto operation. 61 great models at amazingly low prices!

26 Newest Amateur Sets



See the largest selection of Amateur Equipment in Radio! Page after page of the leading manufacturers—new RCA 111, new Hallicrafters models, new Utah X-mitters—a tremendous assortment of the latest transmitters, receivers and transceivers in factory-built and kit form. 20,000 Amateurs buy at ALLIED because ALLIED's service is faster, ALLIED's prices are lower!

68 Newest TEST INSTRUMENTS



25 Modern P.A. SYSTEMS



It's New!
It's Different!
It's Complete!

164 PAGES PACKED WITH VALUES

Send for this great 1938 ALLIED Catalog today! It's new with Radio's latest 1938 developments!—It's different from any other radio catalog ever published!—It's complete with Everything in Radio! Everything you need in one great book—ready to ship instantly from ALLIED's tremendous stocks—every item approved by ALLIED engineers for performance and value!

ALLIED's new 1938 Catalog shows you every type of test instrument—new 2" Cathode Ray Oscilloscope, tube-checkers, set-testers, analyzers, oscillographs, meters. All standard lines at lowest prices! See the new Build-Your-Own test instrument kits, including latest 20,000 ohms-per-volt equipment. Make ALLIED your one dependable source for radio service supplies!

New KNIGHT "Integrated" Sound Systems—every unit perfectly matched! 8 to 60 watts—permanent, portable and mobile—for 110 Volt AC, 6 Volt, and Universal operation—P.A. for every need! New KNIGHT Intercom Systems—2-Way, Selective, and Super-Selective.

ALLIED buys in huge quantities and shares the savings with you. That's why ALLIED's prices are always lowest—that's why thousands of Service Men, Radio Builders, Dealers, Amateurs buy exclusively at ALLIED. You'll save time, trouble and money by doing all of your radio buying from the new 1938 ALLIED Catalog—Radio's Leading Supply Guide. Write for it!

Write for the great new 1938 ALLIED Catalog today! 164 pages, over 12,000 items, separate Radio, P.A., Service, Amateur-Experimenter sections. Radio's easy-to-read, easy-to-shop, easy-to-order-from book!

FREE
Send this coupon

ALLIED RADIO CORPORATION

833 W. JACKSON BLVD., CHICAGO

ALLIED Radio Corporation, Dept. 2-J
833 W. Jackson Blvd., Chicago, Ill.

- Send me your FREE 1938 Catalog—Radio's Leading Supply Guide.
- Send me FREE parts lists for

Name

Address

City State

Please Say That You Saw It in RADIO-CRAFT

MEET ALL RADIO SERVICING EMERGENCIES WITH GERNSBACK RADIO MANUALS AND SERVICE HANDBOOK

JUST as we say—"Be prepared to meet all radio servicing emergencies with the Gernsback Official Radio Service Manuals and Official Radio Service Handibook.

1,200 PAGES
OVER 2500 ILLUSTRATIONS

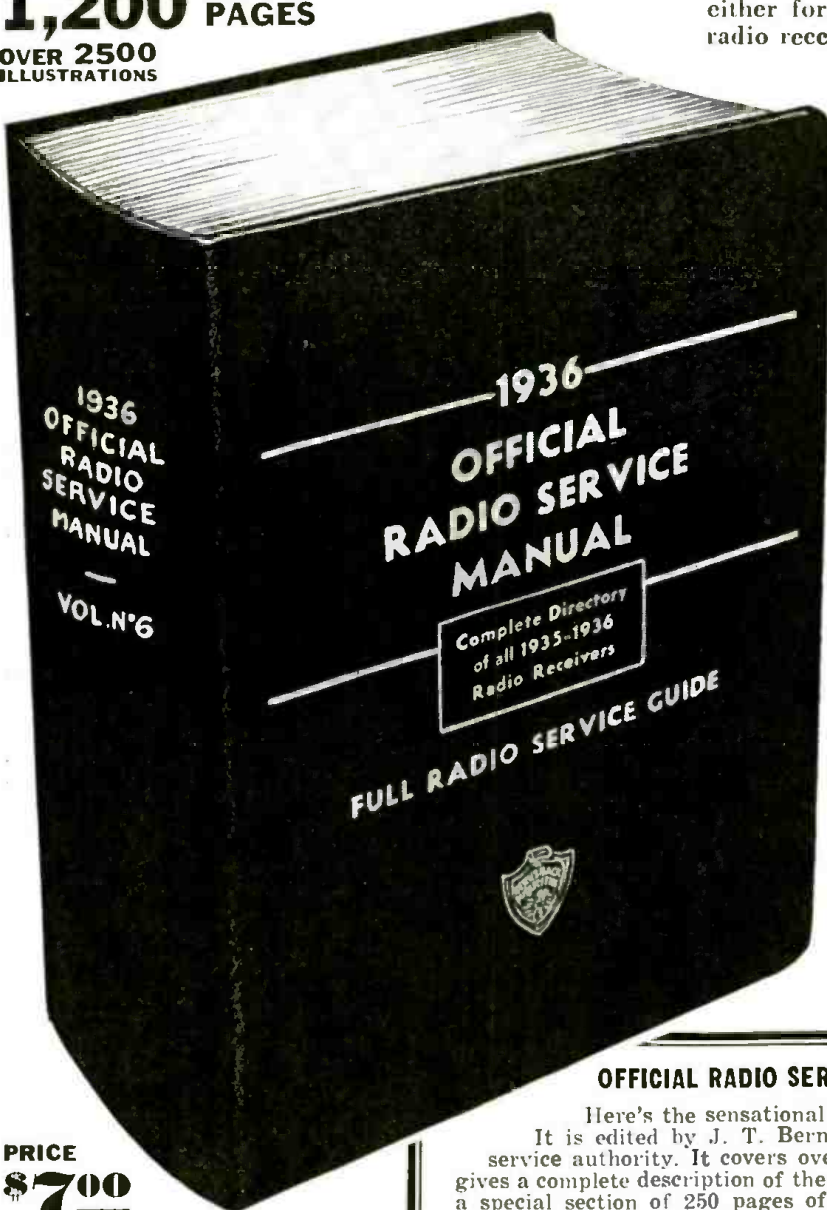

PRICE
\$7.00

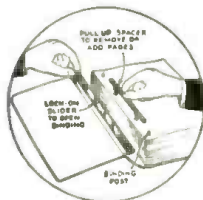

New Practical Binder
Note at the left, the details of the new binder used on this manual. It not only securely locks the 1209 pages into the stiff leatheroid covers, but facilitates removal and replacement of individual pages.

You never know when a service job requires that "extra" special attention. It might mean the difference between doing the job or losing it. You're safe if you have on hand the GERNBACK SERVICE BOOKS—either for regular service work or for servicing auto radio receivers. Get your copy today!

1936 OFFICIAL RADIO SERVICE MANUAL
Packed with service data of sets manufactured during 1935, and 1936—SCHEMATIC DIAGRAMS of over 1,500 manufactured receivers showing speaker connections, power-transformer connectors, R.F. and I.F. coil connections, phonograph connections. On all set diagrams, with few exceptions, the I.F. peaks are indicated, also socket connections. Notes on alignment procedure are printed with diagrams. For over 80% of the sets you will find OPERATING VOLTAGES. Assembly diagrams show relationship of separate units to each other. A complete INDEX of TRADE NAMES and their respective manufacturers. COMPLETE TUBE CHART includes information on hundreds of tubes. CUMULATIVE INDEX contains all sets printed in the 1931, 1932, 1933, 1934, 1935, and 1936 Manuals.

1,200 PAGES * OVER 2,500 ILLUSTRATIONS
Looseleaf Binder—Stiff, Hard Covers
Size 9 x 12 Inches * PRICE \$7.00

1935 OFFICIAL RADIO SERVICE MANUAL
Over 1,000 Pages, 9 x 12 Inches Over 3,000 Illustrations
Flexible, Looseleaf, Leatherette Cover
List Price \$7.00

1934 OFFICIAL RADIO SERVICE MANUAL
Over 400 Pages, 9 x 12 Inches Over 2,000 Illustrations
Flexible, Looseleaf, Leatherette Cover
List Price \$3.50

1933 OFFICIAL RADIO SERVICE MANUAL
Over 700 Pages, 9 x 12 Inches Over 2,000 Illustrations
Flexible, Looseleaf, Leatherette Cover
List Price \$5.00

1932 OFFICIAL RADIO SERVICE MANUAL
Over 1,000 Pages, 9 x 12 Inches Over 2,000 Illustrations
Flexible, Looseleaf, Leatherette Cover
List Price \$5.00

1931 OFFICIAL RADIO SERVICE MANUAL
650 Pages (Including Supplements) 9 x 12 Inches Over 1,500 Illustrations
Flexible, Looseleaf, Leatherette Cover
List Price \$4.50
(Including Supplements)

AUTO-RADIO SERVICE MANUALS

1935 MANUAL
Over 240 Pages 9 x 12 Inches
Over 500 Illustrations
Flexible, Looseleaf, Leatherette Cover
List Price \$2.50

1933 MANUAL
Over 240 Pages 9 x 12 Inches
Over 500 Illustrations
Flexible, Looseleaf, Leatherette Cover
List Price \$2.50

OFFICIAL RADIO SERVICE HANDBOOK

Here's the sensational new book on servicing. It is edited by J. T. Bernsley, well-known radio service authority. It covers over 500 radio topics and gives a complete description of the "Magic Eye." Contains a special section of 250 pages of Operating Notes. The book covers: Circuit Theory and Analysis; Modern Servicing and Test Equipment; Practical Short-cuts in Trouble Shooting and Repairs; Specialized Receiver and Installation Data; Modernization and Conversion Data; Social and Economic Problems of Service Men; and Operating Notes and Practical Data Listings.

OVER 1,000 PAGES * OVER 1,000 ILLUSTRATIONS
Beautiful Linen, Gold-Stamped Cover Size 6 x 9 Inches

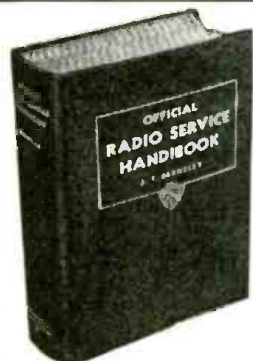

If your jobber or mail order house cannot supply you, order any of the OFFICIAL RADIO SERVICE MANUALS or the OFFICIAL RADIO SERVICE HANDBOOK from the publishers. Send your remittance in form of check or money

order—or, if you send cash or unused U. S. Postage Stamps, be sure to register your letter. ALL ORDERS ARE FILLED PROMPTLY. BOOKS ARE SENT TO YOU POSTAGE PREPAID. Address Dept. RC-937.

RADCRAFT PUBLICATIONS, INC., 99 HUDSON STREET, NEW YORK, N. Y.

GERNSBACK RADIO SERVICE MANUALS ARE AVAILABLE FROM JOBBERS AND MAIL ORDER HOUSES

Please Say That You Saw It in RADIO-CRAFT



"Takes the Resistance out of Radio"

Editorial Offices: 99 Hudson St., New York, N. Y.

HUGO GERNSBACK, Editor

Vol. IX, No. 3, September 1937

WHAT'S NEW IN RADIO?

An Editorial by HUGO GERNSBACK

RADIO STYLES are changing rapidly. New and novel designs are the order of the day. One prominent manufacturer now has a novel slanting tuning dial, making it unnecessary, according to their advertising ballyhoo, to "squat, stoop, or squint." The idea here is to make tuning a pleasure instead of having to assume a grotesque posture, heretofore necessary, as for instance with the dial vertical with your body. ****Then we have the wall-radio measuring only 3 inches thick, that can be hung on any wall by means of a single nail. ****And in order that your icebox does not get lonesome, one manufacturer has equipped it with a radio set calculated to keep the housewife happy.

WHEN IT COMES to sound improvement, the radio manufacturers have gone the whole hog in order to give as much perfection in sound as possible by present-day means. Thus, one manufacturer equips his radio set with no less than 5 separate loudspeakers. ****When it comes to tuning your 1938 set, there is a tremendous amount of ingenuity and novelty. Thus we have automatic tuning not only in the consoles but in the table models also. In some of the sets we have seen, all you need to do is press an opening in a circular dial on which is inscribed the wanted station, and the set does the rest almost instantly. ****Another manufacturer, not to be out-done, gives you instantaneous push-button tuning. There are 6 openings in the tuning dial, each showing the name of a local station. Underneath the name of the station is a push button. When you want the station, you merely push the button and the station comes on automatically without further ado.

BY THIS TIME it isn't news any more to see, as you watch them go by, weird aerials sticking all over cars. You wonder where car antennas will crop out next and what other ridiculous shapes they will assume. Evidently, a Western manufacturer gave this considerable thought for he has just placed on the market a whiskbroom antenna which looks like an over-grown whiskbroom from which wires jut out in all directions. Personally, we don't approve of a number of these antennas and we think that some of them are downright dangerous—when they get to swinging in the wind they may damage either property or life. We predict that the most fantastic of these beetle-appearing types of car antennas will be forgotten by next year.

FOR YEARS, we have been advocating a radio set that would be hermetically closed in the back to keep out dust. It took many years to see this prophecy come true, and we were greatly pleased, lately, to see that one manufacturer has now designed a set hermetically closed and sanitary. Only if you are a Service Man and have had to service a set which had never been disturbed for a year or more and when the slightest breath brought forth a huge cloud of dust, can you appreciate what this simple and important feature means. Incidentally, dust is a pernicious substance. It gets into the variable condensers and other movable parts in your set and often does untold damage there. It is to be hoped that soon all sets will be sealed in the back. Incidentally, the sound reproduction of this particular set is not impaired in the slightest by this simple innovation.

MANUFACTURERS have made great strides in the short-wave end of their sets. It is now far easier to tune a set for foreign reception than it was even a year ago, and the tuning is far less fussy and difficult than heretofore. One well-known set features a new "overseas" dial whereby it is now possible to tune the foreign stations 50 times easier than previously. This is accomplished by having the stations spaced apart a great deal further than was heretofore feasible in a commercial set. This feature alone should be of great interest to short-wave enthusiasts. ****Incidentally, short-wave reception is getting better as many of the foreign stations have better directive antenna equipment now, and a number of other stations have increased their power, so much so that any number of foreign-station programs come in like those of locals on any well-engineered set.

EVERYTHING IS GOING UP, so it would seem, except the price of radio sets. As we look around, we are amazed how cheaply some of the sets can be bought. And rather than having a universal price increase, the trend is either stationary or with many sets, actually lower than they were last year. One mid-west manufacturer is producing extremely low-priced sets—cheaper now than they have ever been produced—due to new manufacturing procedure and other savings made possible by a larger turn-over.

IN THE OFFICE and home intercommunication field, a tremendous amount of progress is the order of the day. More and more, and better, office intercommunication systems are being put out, many of which work over the existing lighting lines—others requiring extra wiring. All of them, however, work on radio principles and many are either private, that is, your customer sitting alongside of you need not hear what your bookkeeper says to you because you can use an earphone if you wish to; or, if secrecy is not required, a loudspeaker, at your option, merely by touching a lever. ****We are still missing, however, the desk radio set which can easily be stowed into your desk drawer so that the busy executive can listen-in to his baseball or news report without having to walk across the room and turn on the radio receiver. A huge market is overlooked by radio manufacturers in this particular item, but sooner or later *it will be made!* Such sets do not need an aerial (in the usual sense of the word). The antenna can be a thin piece of sheet metal placed inside the desk, out of the way; or even a single wire run inconspicuously underneath the top of the desk may be used to accomplish the same function.

TESTING EQUIPMENT, such as tube testers, analyzers, universal meters, oscilloscopes, etc., have had so many new practical features added to them that they virtually "tell" you what is wrong with the radio apparatus under test. Furthermore, their meter scales have been increased and improved so that reference to accompanying charts and graphs is kept to an absolute minimum. Most of the readings taken can be read directly from the meter scales. A "vote of confidence" for these new added features has manifested itself in a tremendous increase in sales for these new testing instruments.

THE RADIO MONTH

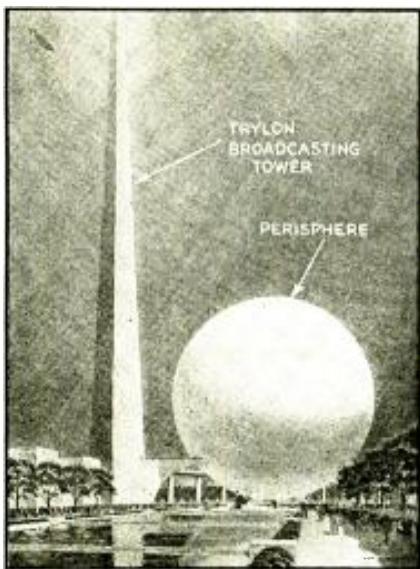

The Trylon (700-foot triangular pyramid tower) of the 1939 New York World's Fair, according to present plans, will be a broadcasting center; and huge directional speakers will project its programs to all parts of the grounds.

TELEVISION SIGNING "FAIR" CONTRACT

WITNESSES to the contract between RCA and the New York World's Fair were numerous, when it was not only signed by David Sarnoff and Grover Whalen, but broadcast by television from Radio City studios last month. RCA in its exhibit (in 1939) will demonstrate motion-picture and phonographic recording, television and transmission of photographs, and broadcasting methods. Of course, as Mr. Sarnoff observed: by then "Television will be greatly advanced over its present-day position."



Design of the new "atom-smashing" tower to be erected by Westinghouse at East Pittsburgh. Inside the 30-foot globe is an electrode charged to 5,000,000 volts, by the tension of which electric "bullets" are shot down on a target 35 feet below. By this means, discoveries of importance in radio and other branches of physics are expected.

ATOM SMASHER TO SOLVE PROBLEMS

AFTER much design work, Dr. L. W. Chubb, director of Westinghouse research laboratories, gave out last month the design of a new atom-smashing experimental plant being constructed. It is the world's greatest piece of experimental apparatus. As shown (lower-left) a pear-shaped tank incloses a vacuum-tube 40 feet long, down which, not electrons, but positively-charged "deuterons" and "alpha particles" (helium ions) will be shot by the repulsive force of a positive plate potential of 5,000,000 volts. This is concentrated on a highly-insulated spherical electrode, and maintained by an electrostatic machine operating on the Van de Graaf system. The minute particles of matter, forced with increasing velocity down the tube, will strike a target at the base of the tube, demolishing the atoms they strike, or converting them into other elements, and generating high-frequency radiation. These projectiles reach velocities as high as a hundred million miles an hour (one-sixth the velocity of light).

GROUND WAVE IDEA IS UNGROUNDED

FOR many years, the idea was generally held that a radio transmitter sends out two waves, a "sky" wave and a "surface" or ground wave—one from the aerial and one from the ground connection. The phenomena of underground reception, with buried aeriels, were taken to support this. In late years, mathematical studies of radio threw doubt on the subject. Last month the *Bell Laboratories Record* announced results of signal measurements, with a 2-meter signal, at distances up to a little more than a mile; over a fresh-water lake which, as a perfect "ground," should give decisive results if there were indeed a "surface"—in this case, "water"—wave. The readings showed decisively that reception is not aided by the existence of a surface wave; or it would be a hundred times stronger.

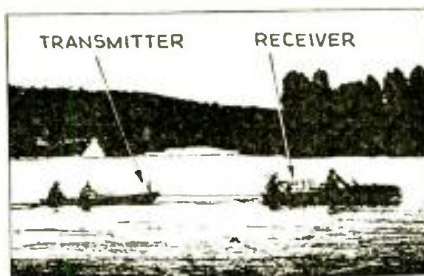

One of the set-ups used by Bell Telephone engineers on Seneca Lake, New York, to measure signal strength, as the rowboat was towed, at varying distances.

SHORT WAVES WILL OVERCOME CANCER

THREE British doctors, taking issue with the present medical position that the only effect of radio therapy is the application of heat, announced in the *American Journal of Cancer* last month that "heat application by short waves is not the same as that by hot iron. The properties of short waves are such that they may provide a very efficient weapon in the treatment of cancer tumors, providing a suitable technique is worked out." Hitherto cancer has had to be cut out, or destroyed by X-rays or radium.

RADIO BUSINESS AT NEW HIGH PEAK

BROADCAST advertising, the NBC announced last month, is the highest on record, in amount of money invested. The company's receipts from this source were almost 17 million dollars in the first 5 months of this year; the increase from sponsored daytime programs was 83.5 per cent over last year.

At the Radio Parts Manufacturers' trade show in Chicago, the largest attendance in 5 years was recorded; there were 6,500 registrations, with visitors from 12 foreign countries, as well as most Canadian provinces.

Figures released by the Department of Commerce last month, as summed up in the graph reproduced below, show a record in radio foreign sales, notwithstanding that several countries, by trade restrictions, have greatly cut down their imports.

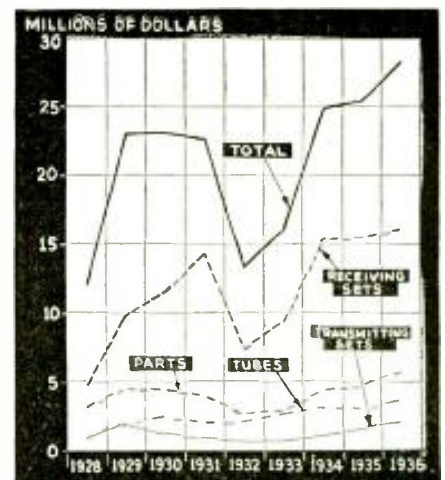

Radio exports of the United States to all foreign countries, in millions of dollars, as tabulated last month by the Department of Commerce; records were again broken in 1936. Great Britain, Mexico, South Africa, Brazil and Cuba were the customers responsible for this great business gain.

IN REVIEW

Radio is now such a vast and diversified art it becomes necessary to make a general survey of important monthly developments. RADIO-CRAFT analyzes these developments and presents a review of those items which interest all.

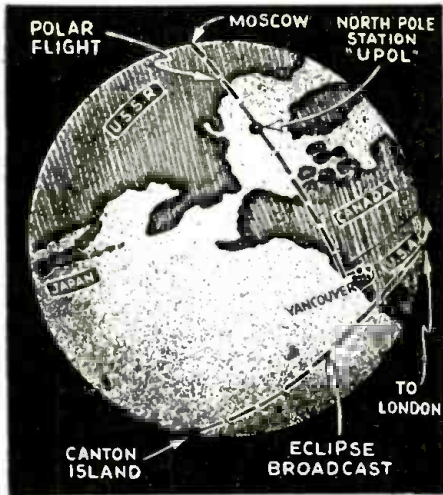

Important spots on the radio map of the world in June. Eclipse expeditions have been made before; and, perhaps, in a year or two, we shall see eclipses by television. But, for the first time, it is now possible to list the North Pole on our radio logs.

SOLAR ECLIPSE ROUND THE WORLD

IN the old days, the record-breaking total eclipse of the sun last month would have been a total secret to all but a few astronomers; for the path of totality was almost entirely over the Pacific Ocean. The NBC, however, sent engineers to Canton Island, to pick it up—at least, to describe it. They flew huge kites to support a vertical antenna—several kites at different levels, to reduce the effect of gusts of wind. The U.S.S. *Avocet* picked up the program, relayed it 4,000 miles to Point Reyes, Calif., from which it was transferred to the regular Blue Network, and also rebroadcast on short waves to Europe. NBC says it was longest broadcast.

RADIO STATION AT THE NORTH POLE

NINE days after last month's eclipse, a very surprising feat was accomplished—also with the aid of radio. The Soviet Government had shortly before landed a party at the geographical North Pole, to remain there for the purpose of making observations; and, on June 17, 3 Soviet aviators set off from Moscow for a non-stop flight to San Francisco, 6,000 miles. Sixty-three hours later they landed at a U. S. field at Vancouver, Wash., having flown over the Pole. During almost the whole trip, they had been in touch by radio with either U.S.S.R. or U.S. stations. UPOL in on 20 and 40 meters.

"STEERABLE" ANTENNA FOR FOREIGN SIGNALS

TO overcome the fading caused, especially in transatlantic short-wave reception, by the radio wave changing its course and the angle at which it strikes the receiving antenna, a new experimental system has been developed to a satisfactory degree, it was announced last month by Bell Telephone engineers. It consists of a line of horizontal loop aerials, lined up in the general direction from which oversea signals are expected. Each has a separate transmission line to the receiving station. By turning a knob on the panel, it is possible to produce the same effect, electrically, as though the aerial system were bodily turned to the angle of sharpest reception; the phase of each signal as it comes in is changed.



The experimental "steerable" antenna equipment, at Holmdel, N. J., is electrically adjusted; just as though one were to turn the loops into line with the incoming signal. The illustration shows a set of 6; but it is likely that 15 or 20 loops may be hooked-up for commercial reception.

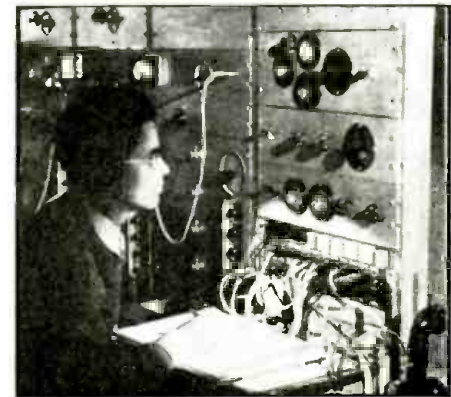

At the switchboard of the "steerable" antenna, a knob permits adjustment of the phases of signal to give maximum effect. Here transatlantic radio-telephone messages are put on the wires. (Bell Telephone Laboratories.)

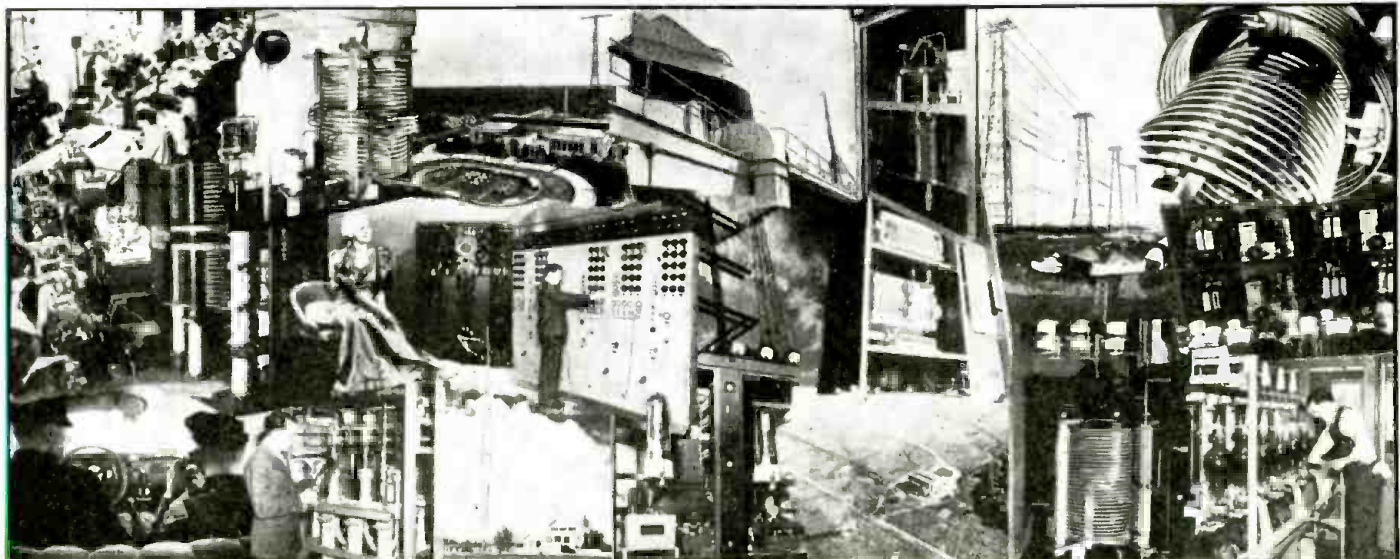

This is a splendid example of the modernistic "photomural"—built up of photographic enlargements on kindred subjects, to give an impressionist's idea of the wide field of radio activities—transatlantic, ship, plane, police, broadcasting, etc. It was made to decorate the new offices of Isolantite, Inc., at 233 Broadway, New York City.

HOW TO MAKE THE RADIO-CRAFT SUPER-DELUXE 30-TUBE SET

PART II



Fig. B. The R.F. all-wave tuner (Chassis No. 1) of the 30-Tube Set.

LIST OF PARTS

CHASSIS NO. 1—ALL-WAVE R.F. TUNER

- One Meissner factory-wired and pre-aligned all-wave tuning unit, No. 7512, 5 band, 3.8 to 555 meters;
- One Stancor power transformer, type P-1570, P.T.1;
- Three Stancor filter chokes, type C-1002, 30 hy., Ch.1, Ch.2, Ch.3;
- *One chassis, 17 x 13 x 3 ins. high, cadmium plated;
- Three Aerovox electrolytic condensers, type GL55, 16 mf., 450 V., C3, C4, C5;
- One Aerovox electrolytic condenser, type 1-6, 4 mf., 475 V., C2;
- One Aerovox tubular bypass condenser, type 484, 0.05-0.05-mf., C1;
- One Aerovox tubular electrolytic condenser, type PR25, 25 mf., 25 V., C6;
- One Aerovox tapped resistor, type 956, 75 W., 100 ohms, with 2 extra sliders, VDR1;
- One Centralab potentiometer, type 75-105, 0.5-meg., R1;
- One Aerovox resistor, type 930, 5 W., 10,000 ohms, VDR2;
- *Three 6-prong sockets (for V4, V6, V7 indicator tubes);
- *Three shielded 4-prong plugs;
- *Two shielded 5-prong plugs;
- *Two shielded 6-prong plugs;
- *Four wafer sockets (two 4-prong, one 5-prong, and one 6-prong);
- *Nine terminal connector lugs, one 3-lug, three 2-lug, five 1-lug;
- Seven General Electric tubes, 6K7, V1; 6L7, V2; 6J7, V3; 6E5, V4; 80, V5; 6G5, V6; 6E5, V7;
- One General Electric molded A.C. line-cord and plug;

(Continued on page 179)

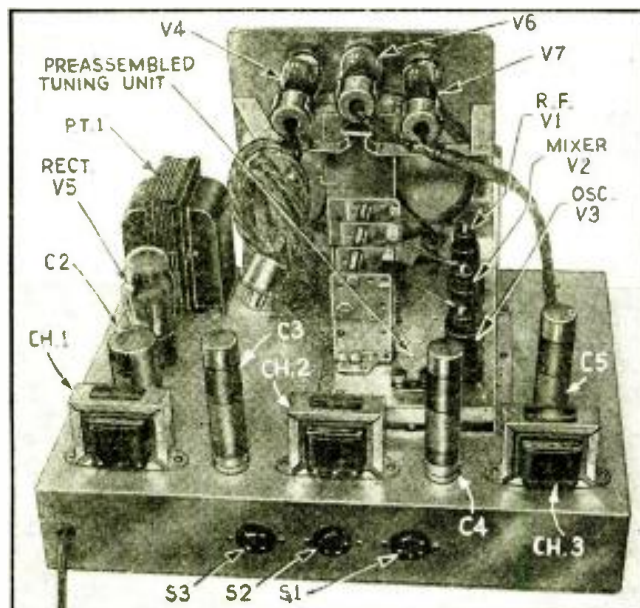

Fig. C. Rear view of Chassis No. 1 showing placement of components.

LAST MONTH, we described the features of an ultra-modern, custom-built 30-tube radio receiver, in which every tube is put to a definite and essential use. We believe that a considerable number of home constructors, short-wave fans, and most all other technically-minded members of the radio family—who have outgrown the “average” radio set and who now want to really “go places” by having a set that incorporates all the most useful and desirable developments which constitute “modern radio”—will find a great deal of interest in the construction details of such a receiver.

The receiver is divided into 4 parts, as follows:
 Chassis No. 1—All-Wave R.F. Tuner
 Chassis No. 2—I.F. and Automatic Circuits
 Chassis No. 3—A.F. Power Amplifier
 Chassis No. 4—Power Supplies, Speaker Baffle and Chassis Framework

In this, Part II, we will take up only the construction of Chassis No. 1. In subsequent issues of *Radio-Craft*, we will give construction details of the other 3 chassis. In this way, each chassis will be treated in much greater detail than would otherwise be possible. This plan also helps those builders who cannot afford to buy all the parts for the complete set at one time.

MOUNTING THE PRE-ASSEMBLED TUNING UNIT

The largest single item necessary for the construction of this chassis is the Meissner tuning unit. We have chosen the No. 7512 unit because we wanted ultra-shortwave reception—right down to (and even below!) the television band where the special high-fidelity *sound* transmissions that accompany the *video* (image) transmissions may be heard. For those constructors who prefer the long waves, up to 2,140 meters (but tuning-in short waves only down to 7.5 meters), the No. 7511 unit may be substituted and no changes of any kind, either electrically or mechanically, will be needed. See Fig. 4 for the schematic diagram of No. 7512 tuner.

As shown in the schematic diagram Fig. 2, only 8 leads emerge from this unit. The two black leads are for the filaments and pilot lights. The white lead is not used and should be cut off at the switch contact. The remaining 5 leads are tied to insulated terminal lugs for later connections to other components.

Mark off, according to Fig. 3, all the holes required on the chassis. The large rectangular opening required for the tuning unit must be carefully measured and cut out. The author used an ordinary hacksaw blade (with one end taped-up for a handle) inserted in each of 4 holes drilled within the corners of the rectangle markings.

After the cut-out is finished, the tuning unit should be inserted and 3 small holes on each flange should be marked off. Remove the tuner, drill these 6 holes and again try the tuner for fit. If all is well, remove the unit and lay it aside. Do not attempt to punch or drill holes in the chassis with the unit in place because the vibration or shocks may seriously alter the alignment or break the glass dial-face.

The next item is to punch out 6 holes with a 3/4-in. chassis punch. Two of these holes are for the power transformer leads, the other 4 are for the electrolytic condenser cans. The first filter condenser, C2, has a lug riveted to its side. Drill a 3/4-in. hole for this lug and be sure to insulate the

Every technician with an average amount of set-building experience can successfully construct this superlative radio receiver. Cost?—at mailorder-house prices, under \$250! Build any of the 4, separately-usable chassis and RADIO-CRAFT—in co-operation with Mr. Charles Sicuranza—will if necessary repair your set gratis (under conditions named)!

R.F. ALL-WAVE TUNER

lug from chassis. Four holes of 1 3/16-in. dia. are required. One of these is for the 80-tube (rectifier) socket while the other 3 are located on the rear apron of the chassis. When these holes are punched, the sockets may then be riveted or bolted on.

Drill 6 small holes for mounting the filter chokes. Drill a 1/4-in. hole and insert a rubber grommet for each pair of choke leads. Drill a 3/8-in. hole for the A.C. line cord and another for the cable leading to the indicator tubes. Another 3/8-in. hole is required for the volume-control shaft which protrudes from the front apron. Mount the tapped resistor under the chassis and continue with the mounting of the other parts. Finally, mount the tuning unit. Be sure to mount the terminal lugs (mentioned above) for making subsequent connections to the tuner leads more convenient.

The next steps depend upon the builder's choice of mounting locations for the 3 indicator tubes. We made up a bracket and clips from 1/2-in. aluminum strips. Commercial tube brackets may be conveniently used. (The front-panel template may be omitted as it was made only to show the method of mounting the dial escutcheon and indicator tube positions.)

WIRING

The wiring is done next. Note that all the negative condenser leads are connected to the voltage-divider resistor, VDR 1, at a point which is 6 V. negative with respect to chassis; see Fig. 2. The leads from the socket of the A.F. overload indicator, V4, should be 48 ins. long, shielded all their length and terminate in a 4-prong plug, as shown in Fig. C. Only 3 leads underneath the chassis are shielded. One of these is the I.F. plate lead and the other 2 are the audio volume control leads.

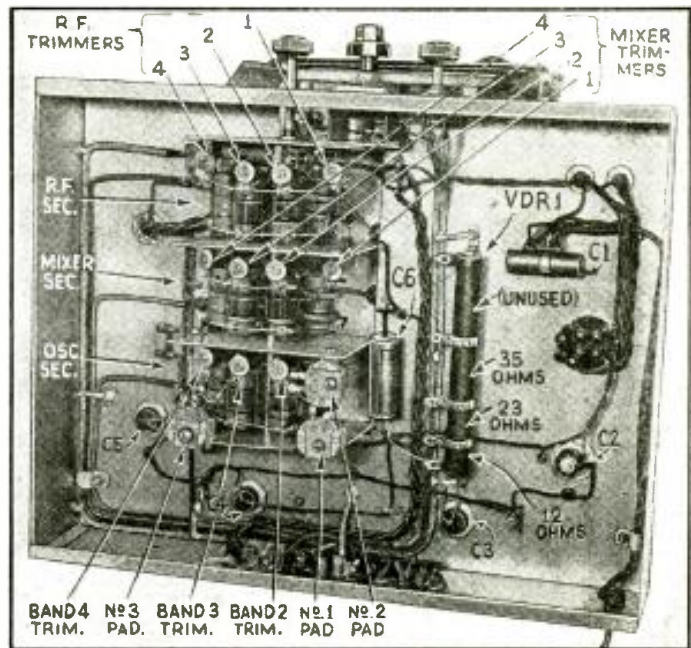

Fig. D. Under-chassis view showing the locations of the band trimmers.

Three cables are required to connect chassis No. 1 to chassis No. 2. Each cable should be 24 ins. long over-all. Two plugs terminate each cable, one plug at either end. Copper braid sheathing is used to enclose the wires in each cable, and is soldered to the cadmium-plated shells of the plugs.

The power supply on chassis No. 1 is designed to supply "B" current for the tubes in chassis No. 1 and No. 2. The fixed-bias voltages are applied to the automatic bass amplifier on chassis No. 2. There is available sufficient filament current to light 4 additional tubes on chassis No. 2 besides the tubes on chassis No. 1.

FINAL CHECK-UP OF CHASSIS No. 1

When the wiring is completed, check it VERY CAREFULLY against the schematic diagram. If the builder is anxious to test the performance of the tuner, the following procedure must be carried out. An I.F. channel of 456 kc. with A.V.C. must be used. Connect the I.F. plate and plus 250 V. holes of the 5-prong socket on rear of chassis No. 1 to the 1st I.F. transformer in the I.F. channel. Connect the A.V.C. prong to the A.V.C. network in the I.F. channel.

(Continued on page 175)

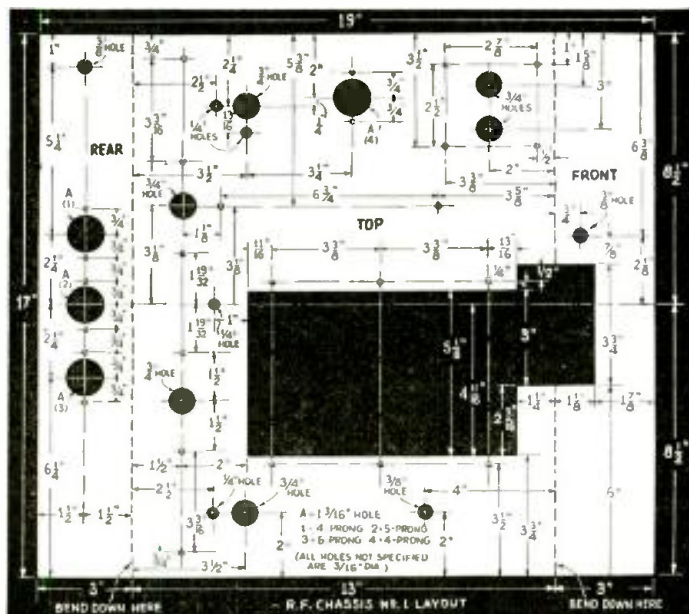

Fig. 3. Exact physical specifications for construction of the chassis.

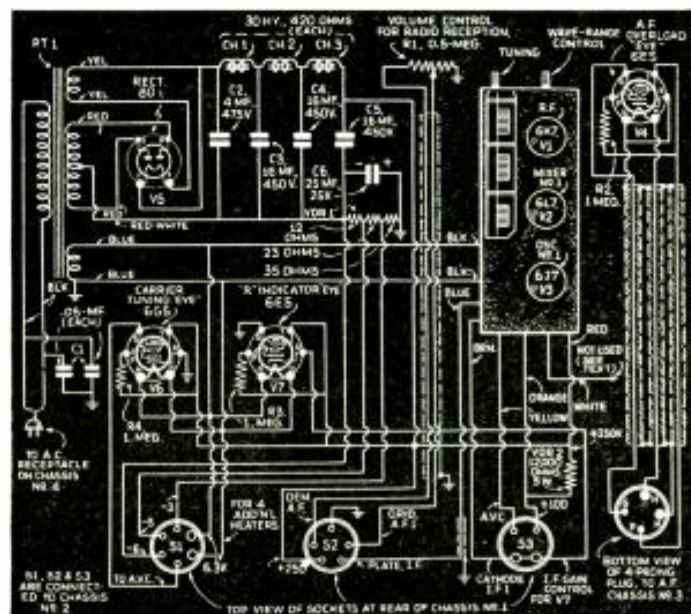
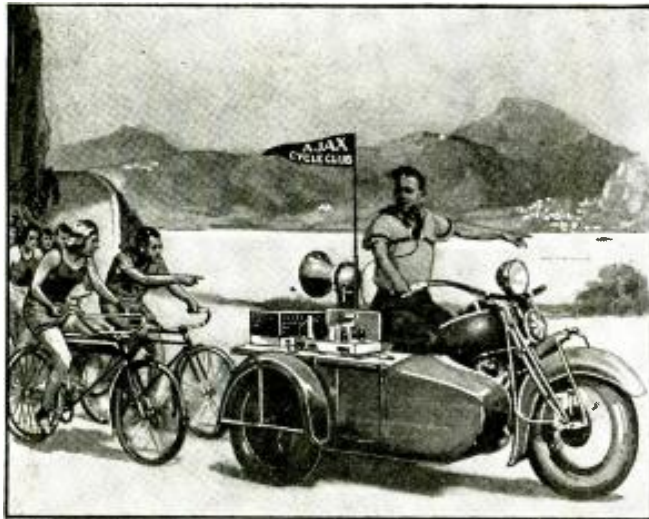

Fig. 2. Schematic diagram of the R.F. all-wave tuner; Chassis No. 1.



CLEVER RADIO set builders will have no difficulty putting into practice the idea, suggested by *Radio-Craft*, which is illustrated above and in the painting in colors reproduced on the cover. In short, a radio set and public-address amplifier combined with a reproducer to produce a useful adjunct to itinerant groups. The cyclecade may be a party of bicyclists; or on the other hand motorcyclists may wish to apply this idea. In the latter instance a power amplifier with somewhat higher output would be required in order to overcome the increased noise level.

The pleasures of a jaunt through the countryside accompanied by a guide well acquainted with the route would be immeasurably enhanced by the use of a public-address system such as here outlined. It seems rather odd that no one has thought to put this idea into practice. Its possibilities

RADIO AND P.A. FOR TOURING CYCLISTS

Regularly scheduled bicycle tours are now the vogue. RADIO-CRAFT suggests the following idea as a practical adjunct.

are many, the equipment is easy to set up and operate, and the cost is low.

The guide may be the driver of the lead motorcycle; or the equipment rearranged to provide space in the sidecar for the guide.

Descriptive remarks regarding scenic attractions may be interspersed from time to time by musical selections picked up by means of the radio receiver. Wayside stops may be similarly enlivened by means of radio program pick-ups amplified by the P.A. system.

It probably will be apparent to the veriest tyro that the only requirement to affect the change from radio to public address is a simple 2-way switch. In one position the microphone, arranged in a breast mounting, is connected to the power amplifier; and in the other position the output of the radio set is fed into the power amplifier. Flying a club pennant at the head of the column always lends éclat, but added utility has been achieved as our illustrations show by utilizing the short pennant mast as a pole antenna for the radio set.

An exceptionally simple arrangement of regenerative radio receiver and straight-forward commercial amplifier,
(Continued on page 185)

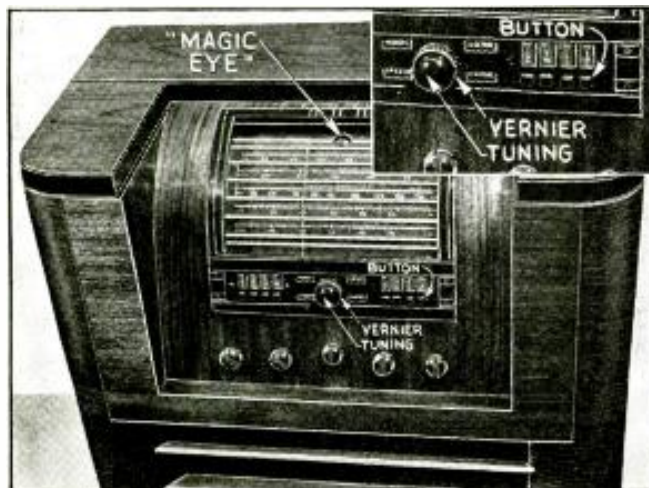

RCA Victor "pushbutton" tuning receiver model 816-K.

ENGINEERS of the RCA Victor laboratories have perfected a new electric tuning system, which has been incorporated in many of their new radio and radio-phonograph instruments, by means of which one need merely press a button and his favorite radio station is tuned-in instantly and more precisely than he could do it manually. It is as easy as all that and there doesn't seem to be any catch to it.

There are 8 of these buttons. Each of them can be pre-set to different radio stations and these stations precisely tuned-in by pressing their respective button. The development of automatic frequency control, more than anything else, is responsible for this new electric tuning feature.

Reduced to its simplest terms, this means that, in automatic operation, the radio circuit will actually adjust itself to compensate for any variation in the mechanical system

"BUTTON TUNING" IS THE NEWEST CONVENIENCE

Aladdin had to rub his magic lamp to accomplish complex things. The owner of a modern radio receiver need but push buttons to have complex, precise tuning operations automatically performed for him.

so that the station is precisely tuned to its most resonant point. Pressing any of the buttons sets a motor into operation which turns the tuning condenser to the approximate position of the station wanted. The action of the automatic frequency control circuit then adjusts the frequency of the oscillator so as to bring the station exactly to resonance.

As an added luxury, a remote tuning "arm-chair control" is available. This control consists of an attractive but unobtrusive little box on the face of which is duplicated the push-button arrangement of the radio receiver. This control box may be inconspicuously placed on the arm of a chair or on an end-table and connected to the radio set by a thin cable that lies flat under a rug or along the wall molding.

Another interesting feature is the "overseas dial" which tends to simplify the tuning of short-wave stations. The 4 most important short-wave bands have been spread out in a straight line across the dial in front of the radio set. For instance, the popular 25-meter band which formerly occupied a space on tuning dials never more than 1/2-in. in length has been spread out to 9 1/2 ins., and the important
(Continued on page 186)

A SELECTIVE POCKET-SIZE CRYSTAL SET FOR BEGINNERS

Beginners in radio will appreciate the simple description of this elementary, home-made, pocket-size crystal receiver. The entire set, exclusive of the headphones, can be constructed for less than \$1! The circuit is simple enough for the beginner, yet selective enough to bring in several stations without interference between each other.

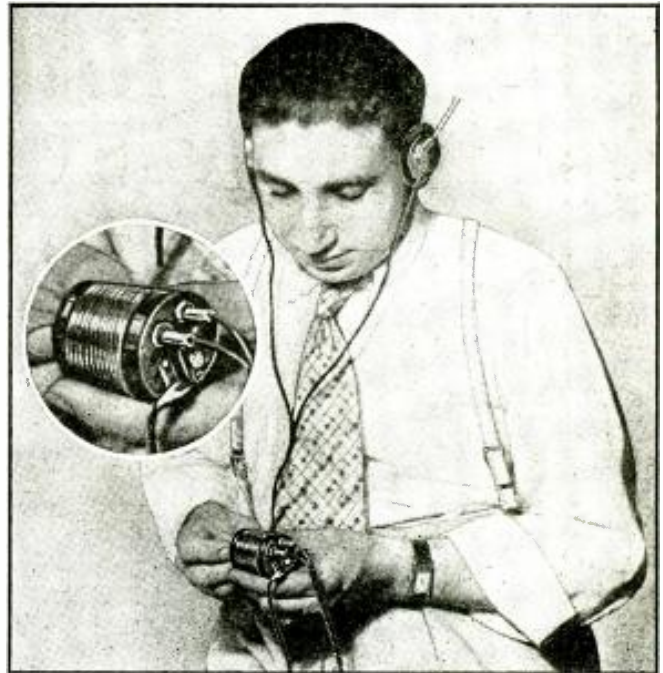

Fig. A. Note the small size of the crystal set compared with that of the listener. The inset shows an enlarged view of the set.

N. H. LESSEM

MANY PEOPLE would like to try building a radio set but hesitate to do so because of the fear of spending money for equipment and then getting no results. Even a crystal set can run into some money, but of course such a set is the simplest and cheapest for the beginner. Keeping in mind the desire for an inexpensive set, the one shown in use in Fig. A was made up. It is quite diminutive, although no particular effort was made to produce an "ultra-midget" set. All the parts being small, the result is a small set that can easily be slipped into a coat pocket.

CONSTRUCTION DETAILS

The case is a piece of tubing, either cardboard or bakelite, 1 1/4 by 1 1/2 ins. Two ends are made, of any convenient material (even cigar box wood!) and one end is glued in. See Fig. 1A, for the layout of the parts.

The tuning condenser is a so-called padding type, and should have a capacity range of 120 to 330 mmf. This condenser is fastened to the end of the case which was glued in, 2 small screws being used for the purpose. Since the condenser is operated by means of a

SPECIAL NOTICE
RADIO-CRAFT takes this opportunity to announce that the October issue, on the newsstands Sept. 1, will be a special
TEST EQUIPMENT NUMBER

screw which is too short to fasten a knob to, the screw must be replaced with one about 1 in. long. A small knob is fastened to the outer end.

The coil may now be wound in place. It consists of 100 turns of No. 28 double silk-covered wire. The ends pass through holes in the tubing to connect to the circuit.

The other end of the case must be removable and may be made simply a "press" fit. In it are drilled holes for 2 phone tip-jacks, 2 binding posts, and the crystal detector. The latter consists of a mounted galena crystal, soldered to a bolt that passes through the case end. Another bolt holds a short piece of fine, spring wire that touches the crystal surface lightly. This wire is termed the "catwhisker."

The wiring is very simple. The phone condenser is connected directly to the

end of the pin-jacks and the other necessary connections made as shown in Fig. 1B and C; then the end is pushed into place.

OPERATION

Operation is simple and certain if the circuit has been carefully followed. A good ground and a fairly long antenna are essential if the receiver is to be used more than about 25 miles from a powerful station. If closer, a much shorter antenna will do. To work the receiver it is necessary for the "catwhisker" to make contact with a sensitive spot on the crystal, and this can be ascertained by operating a doorbell, buzzer or any other spark-producing device near the antenna. If the buzz

(Continued on page 185)

LIST OF PARTS

- 1 Solar padding condenser, 120 to 330 mmf., C1;
- 1 Solar fixed mica condenser, 0.001-mf., C2;
- 2 phone tip-jacks, J;
- 1 mounted crystal, C;
- 2 small binding posts, ANT., Gnd.;
- Wire and tubing for unit L;
- Hardware.

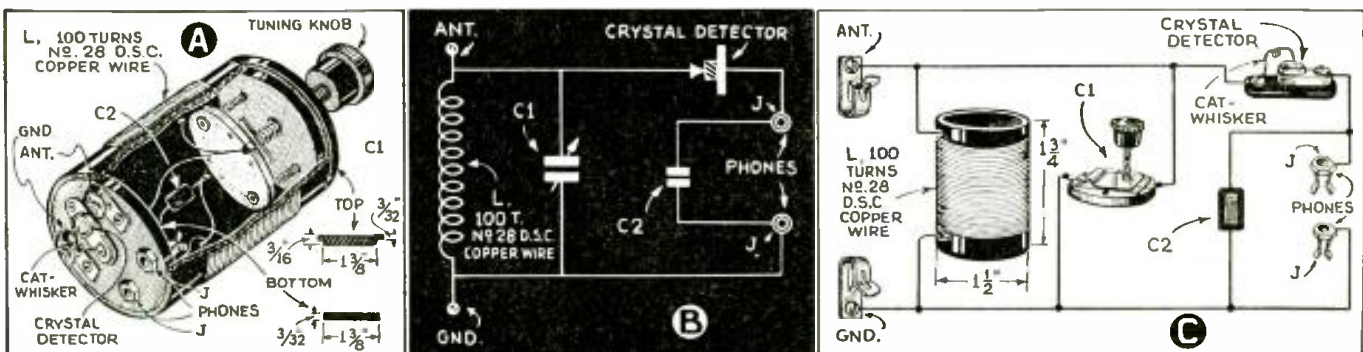

Fig. 1. A—cut-away view showing placement of parts; B—schematic circuit of crystal set; C—for those who cannot read schematics, this is a pictorial diagram of all parts and connections.

INTERNATIONAL RADIO REVIEW

RADIO-CRAFT receives hundreds of magazines from all parts of the world. Since the cost of subscribing to each of these would be prohibitive for most radio men, we have arranged with technical translators to prepare reviews for our readers.

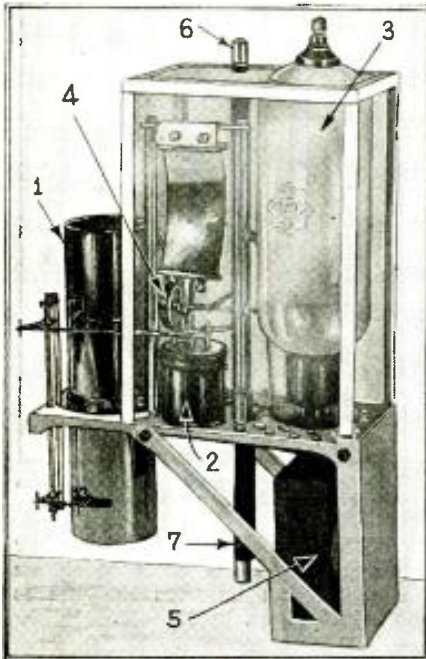

Fig. A. Miniature balloon transmitter used for meteorological surveys of the stratosphere.



Fig. B. Portable battery radio set in camera case.

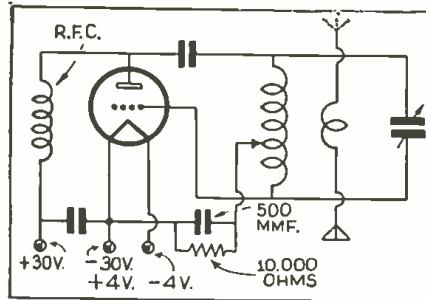

Fig. 1. Circuit of meteorological transmitter.

ENGLISH "FULL-VISION" TUNING DIAL ON TOP OF CABINET

A PRACTICAL English version of a console radio receiver with "full-vision" tuning, as described in a recent issue of *Wireless Retailer & Broadcaster* (London). A large, circular, full-vision scale with "stereoscopic illumination" is fitted in the top of the cabinet and is fully calibrated in station names and wave-lengths. Tuning is accomplished with a single knob, giving an automatic 2-speed tuning. In addition, there is a 3-position tone control combined with a selectivity control. The cabinet is executed in feather-grained walnut and Macassar ebony, while the speaker grill is of antique brass metal. The chassis has provision for an external speaker as well as for a phonograph pickup. See Fig. C.

A CAMERA-CASE PORTABLE BATTERY RECEIVER

THE "POCKETPHONE," a portable receiver in a camera case, is described in a recent issue of *Wireless World* (London). It was designed especially for use on the route of the Coronation procession and was reported to have met with much success (see Fig. B).

The leather carrying-case measures only 8½ x 6 x 2½ ins. thick and is provided with a strap so that the set can be slung across the shoulders, leaving both hands free. Access to the controls is gained through a flap which, when shut, automatically switches off the set. A 3-tube circuit is employed, an interesting feature of which is the use of resistance-capacity coupling in the R.F. stage. The aerial is wound around the inside of the case and is tuned to cover the usual European medium-wave band. The set is a little heavier than a pair of binoculars.

NEW ELECTRO-MECHANICAL A.F.C.!

"STATIONS THAT TUNE THEMSELVES" is the title of an interesting article, appearing in a recent issue of (*Supplement*) *Wireless Retailer & Broadcaster* (London), de-

scribing a new "touch" system of automatic tuning. Essentially, the system is A.F.C., accomplished electro-mechanically. The article, in part, follows:

The idea is to make the incoming signal automatically "lock" the tuning control shaft in position at the precise point where the circuits come accurately in tune. If one starts, say, from the lower end of the indicator scale, the control knob will rotate freely until the first station comes in. As the pointer reaches the correct wavelength on the scale, a brake automatically comes into action and holds the control shaft against any further movement.

After a certain interval of time the brake is automatically released. But if the listener does not then have the station he wants he can, without waiting for the "automatic release," at once push the knob slightly inwards to short-circuit the brake control. The spindle will then again turn freely, until the next incoming signal once more applies a check.

By keeping the knob depressed, it is possible to move freely all over the scale, and to bring the control rapidly to any particular program that is

(Continued on page 172)

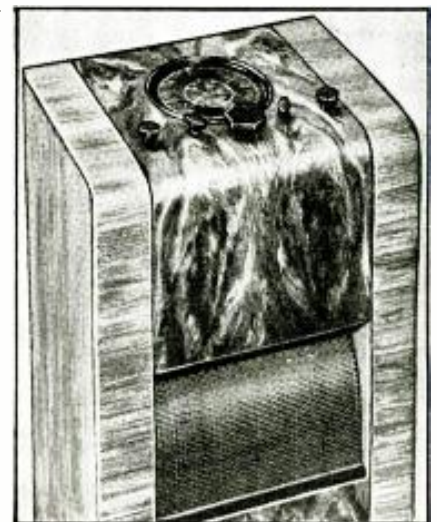

Fig. C. Console radio set with tuning controls on top.

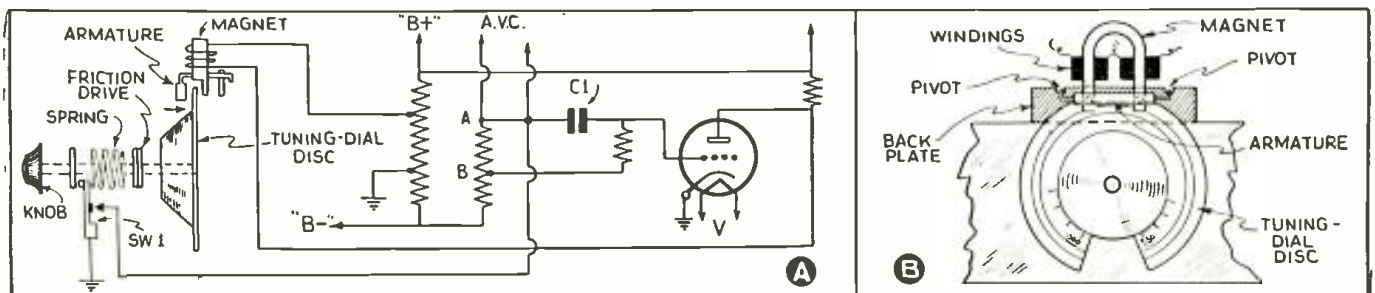

Fig. 2. A, Circuit of electro-mechanical A.F.C., or "touch tuning" system; B, Details of the magnetic brake.

COSMIC RAYS

SHORTEST WAVELENGTH IN THE WORLD

Cosmic rays are the Alchemists of Nature, transmuting one metal into another and producing many effects as yet undreamed-of; coming from interstellar space — the dark, "empty" areas between the galaxies — they bombard the earth with almost unbelievable power, and with 100 times the penetrating strength of our X-rays. Read about these rays, and how Dr. Compton (University of Chicago) and Dr. Bennett (Massachusetts Institute of Technology) use a lead "bomb", with walls 15 inches thick, as a "cosmic ray receiver".

L. S. FOX

THE KNOWN RANGE or spectrum of the ether begins with wavelengths of about 30,000 meters or frequencies of about 10 kilocycles. From this point to about .04-centimeter or 7,500 megacycles is included the Hertzian or radio waves. Next follow the waves of heat, infrared, visible light, ultraviolet, X-rays, alpha, beta, and gamma rays, and those of the shortest wavelength and highest frequency, the *cosmic rays*. In the high-frequency end of the ether spectrum are X-rays of frequencies up to 2 trillion megacycles; alpha, beta, and gamma rays emitted by radioactive substances, of frequencies up to 300 trillion megacycles; and, highest of all, *cosmic rays*, whose frequencies go up to 30,000 trillion megacycles!

Because of their tremendously high frequencies, the penetrating power of cosmic rays is enormous. The hardest X-rays of the laboratory will penetrate perhaps a half-inch of lead, but the cosmic rays, after passing through the whole of the earth's atmosphere (equivalent to a layer of 3 ins. of mercury) still retain sufficient energy to penetrate 200 ft. of water, equivalent to about 18 ft. of lead.

X-rays are produced by the impact of electrons against a target in an exhausted tube. The speed of the electrons can be regulated by the voltage applied to the terminals of the tube, and the higher the voltage, the higher the frequency of the X-rays produced. But no ordinary source of electrons is able to produce the extremely high frequencies of the cosmic rays.

HOW COSMIC RAYS ARE DETECTED

Cosmic rays may be detected and their fluctuations of intensity measured by use of the phenomenon of *ionization*. Ionization is usually thought of as the passage of an electric current through a rarefied gas resulting in the production of light, as in the neon lamp.

We picture an atom as a nucleus associated with one or more electrons rotating about it. The nucleus is positive, the electrons are negative, so there is a strong attraction of one for the other. It takes energy or work to separate an electron from its atom. When an ether wave, which is made of nothing but energy, strikes an electron forcibly enough it will separate it from its atom. The atom is then said to be ionized. It has lost its negatively charged electron, so its charge is positive. If it is an atom of gas within a closed vessel having a cathode and a positively charged anode it will be attracted to the cathode and its free, negatively charged electron will likewise be attracted to the anode. Thus,

(Continued on page 173)

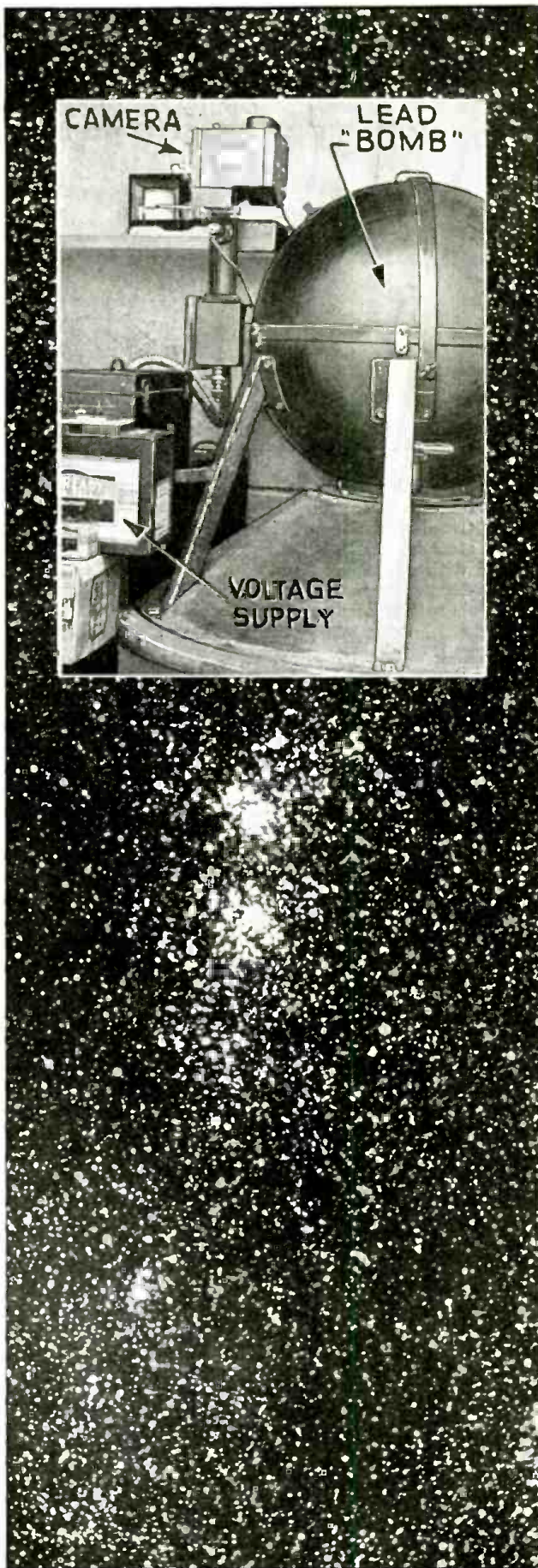

Photo of a double star-cluster in Perseus, near one of the Milky Way's galaxies. Scientists say the "empty" areas between such galaxies in interstellar space radiate, on a frequency as high as 30,000 trillion megacycles, "cosmic rays" that manifest their presence by virtue of having penetrated a lead wall 15 ins. thick! One of these "receiving sets" is shown above, inset.

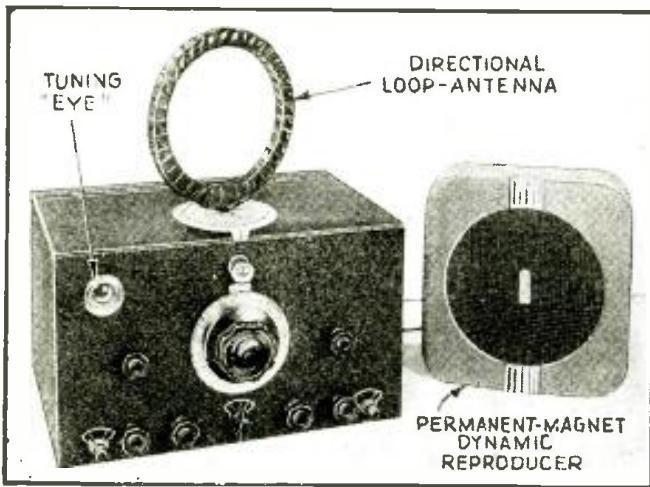

Fig. A. Appearance of "The Seafarer" radio set and direction finder.

HOW TO MAKE "THE SEAFARER" LOOP-TYPE BOAT RADIO SET

This marine-radio set permits both direction finding and the reception of broadcast programs. Including "eye," a 7-tube set.

PART I RAYMOND P. ADAMS

"THE SEAFARER" is primarily designed for sensitive, directional-reception of broadcast-station signals, but it is further provided with a means for switching to both low-frequency ranges covering the regular shore and airways beacon stations, and high-frequency ranges for short-wave DX-ing.

ADDITIONAL FEATURES

As a matter of fact, its only radical departure from ordinary mobile ("car-radio") receiver design is its use of a small tuned plug-in "loop" (see Fig. A) replacing the usual antenna and antenna coil. Its circuit is simple and easily understood, so that any radio-builder, familiar with the principles of standard superheterodyne construction, should be able to duplicate the laboratory model.

The average radio receiver, with a few minor and unimportant alterations here and there, may be easily adapted to direction finding and general maritime service. Conversely, the typical, modern-day and non-commercial direction finder may be revamped, without much trouble, for broadcast reception. This does not imply that equipment manufactured for home use will stand

up properly in extremely humid and salt atmospheres, but it does imply that a circuit basically suitable for the one type of instrument remains fundamentally proper for the other; and that a combination job involves no great complexities, either of circuit or construction.

A crackle-finish metal cabinet, true vernier dial, self-contained genemotor power supply, full, all-wave superhet. hookup, high gain (amplification) and sensitivity, loudspeaker output, visual tuning (by means of the electronic "eye"), and permanent-magnet dynamic reproducer; these are some of the features of this instrument. It costs very little to construct, and compares favorably with \$200 commercial "finder" jobs. It stands up with the best of competitive supers., and affords the professional set-builder an opening to profitable sales in a relatively untouched field.

THE CIRCUIT

Six tubes are employed in a straight (except for the input part) all-wave superhet. circuit. The 1st-detector and high-frequency oscillator stages are equipped with the usual shielded broadcast coils, and a switch permitting a

shift to either the 140 to 400 kc. beacon band or to such short-wave bands for which the individual builder secures coils. (In the laboratory model, coils for the 5.9 to 18 mc. band have been installed and are shown in the under-chassis photograph.)

The loop circuit supplants the conventional R.F. coil set-up and antenna, as previously mentioned. It is roughly tuned by one section of the 3-gang condenser that governs signal selection. A 150 mf. separate variable condenser bridged across this section permits exact tuning to the desired signal frequency. The use of a rather low-inductance loop makes possible the sharp, clean-cut signal so necessary to accurate direction finding. (Antenna coils may, of course, be wired-in for the short-wave band or bands, as shown in the schematic diagram, Fig. 1, through the designation "L optional". Their use would call for a separate antenna post, to which a short-wave aerial may be conveniently connected. Removal of such an antenna would be desirable when tuning to broadcast or long-wave signals, especially when direction-finding.)

We will not discuss the conventional R.F. and mixer tube circuits except to say that neither tube is A.V.C. con-

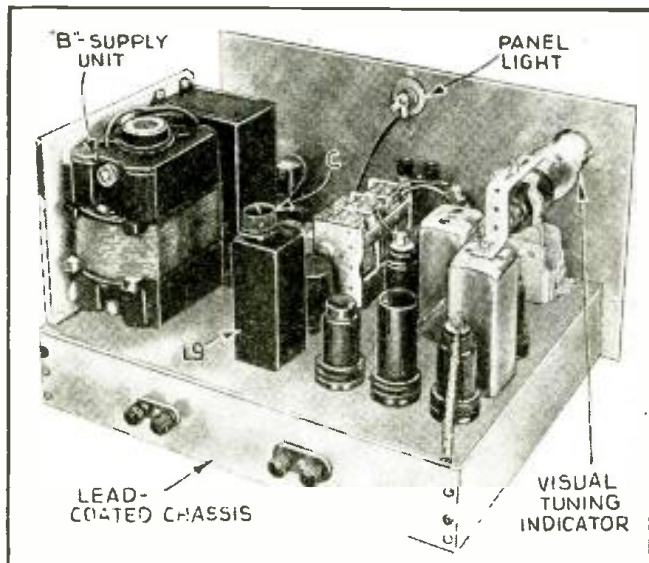

Fig. 3 Rear view showing placement of parts and power pack.

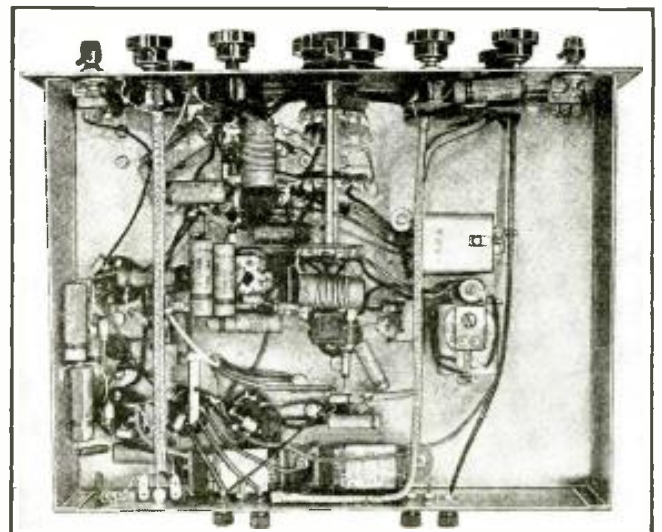

Fig. C. Under-chassis view showing wiring and positions of small components.

trolled (A.V.C. being confined to the I.F. stage); and to mention the fact that both stages are designed to work at fullest possible efficiency. The 6K7 R.F. tube cathode-limiting resistor is returned, not to chassis, but to a potentiometer for manual control of sensitivity—a convenience we simply must have for adjusting the visual resonance indicator or tuning "eye" shadow to an optimum point for either maximum or minimum finder reading. (See Fig. 5 for detail of tuning "eye" connections.) The screen-grids of both the 6K7 and the 6A8 mixer are series-fed, and plate circuits are adequately decoupled and bypassed. *Perfect R.F. stability is imperative.*

Both I.F. transformers are of the ferrocarr iron-core variety, assuring us of highest possible gain and selectivity in a single stage using a 6K7. Like the cathode in the R.F. stage, the I.F. tube's cathode is returned to the sensitivity potentiometer. Its screen-grid is series-fed, and its plate circuit is decoupled and bypassed.

The 6Q7 2nd-detector supplies both (1) an A.V.C. voltage to the single I.F. stage and (2) a self-amplified A.F. voltage to the output pentode. The 6F6, connected for the familiar pentode operation, feeds a 3-W. output into the permanent-magnet, high-efficiency speaker, with which the impregnated and protected output transformer is an integral part.

As there are times when a modulated signal level may be so weak as to be inaudible and at the same time unreadable on the tuning "eye" 6E5, a beat-frequency oscillator stage has been added for carrier reception. The circuit uses a 6C5, with the output capacity-coupled to the 2nd-detector circuit. This is accomplished by means of an insulated wire, one end of which connects to the triode plate; the other end is wrapped a few times around the 6Q7 diode lead.

The power supply is approximately

300 V. at 70 ma. from a selected genemotor or dynamotor unit (the terms are synonymous)—sufficient to permit additional filtering through a 400-ohm choke in the "B"-plus line, if such filtering is found necessary in individual cases. Tube filaments and genemotor are operated from a regular storage battery of 6.3 V. output rating. Leads to the power supply from the battery may or may not require R.F. filtering, largely depending upon whether or not short-wave reception is to be had. Similarly, the "B"-plus lead may or may not require an R.F. choke at the output of the dynamotor.

MARINE SERVICE DEMANDS SPECIAL EQUIPMENT

The circuit may be conventional enough, but the materials used in this maritime receiver, however much they may seem to be of ordinary manufacture, have been especially selected and prepared for efficient service in salt, humid atmospheres. Bearing this clearly in mind, the importance of the following description then becomes more forcible.

It cannot be too frequently stated that "regular-run" components may not stand up in prolonged maritime service. Sea air is wet, corrosive, laden with chemicals; it breaks down insulation, and causes electrolytic action. No metal, particularly if unplated or poorly plated, will afford ample protection to delicate parts. Transformers "go to pot." Dielectric conduction increases through moisture absorption. Water—salt water—gets in everywhere; it fairly saturates every minutely porous thing in the radio set, causing shorts and general breakdown.

Consider what would happen to an unprotected carbon resistor, to unwashed and untreated wire insulation, to coil components, to A.F. transformers, to speaker cones—unless some very definite steps were taken to insure their freedom from the effects of

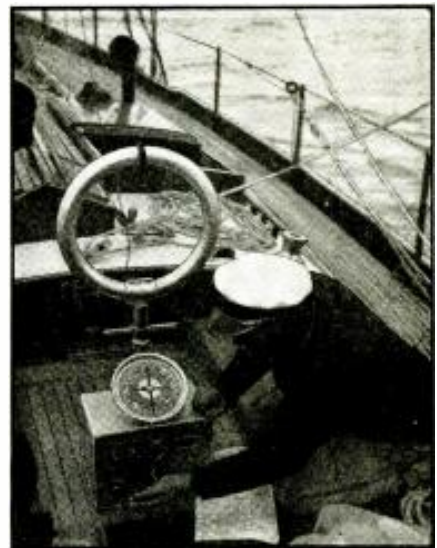

Fig. D. A Gloucester fisherman is here shown using a commercial make of marine radio direction finder. The position of a school of fish is charted for future reference by the use of this Bloodwell direction finder. Various lighthouses constantly broadcast (as part of their regular routine) a dot-dash signal. The direction of 2 or more of these houses is located (with the "finder") and spotted on a chart. The point of intersection of straight lines drawn through these spots indicates the position of the ship and hence the school of fish; this prevents wasting hours in a search (on the next fishing trip) covering many miles.

electrolysis, or corrosion, or just plain water absorption. The following precautions were taken:

(1) We secured a **LEAD-COATED CHASSIS**—and a cabinet with similarly leaded interior—if for no other reason than to assure us of **PERFECT SOLDERED CONTACTS TO CHASSIS GROUND**. (ALL contacts throughout the set are soldered carefully, by the way, to prevent possible corrosion, increased resistance, perhaps contact **DETECTION**.)

(2) We used **INSULATED** resistors throughout—resistors protected by heavy bakelite coatings. All values are rated at 1/2-W. They are small but able
(Continued on page 168)

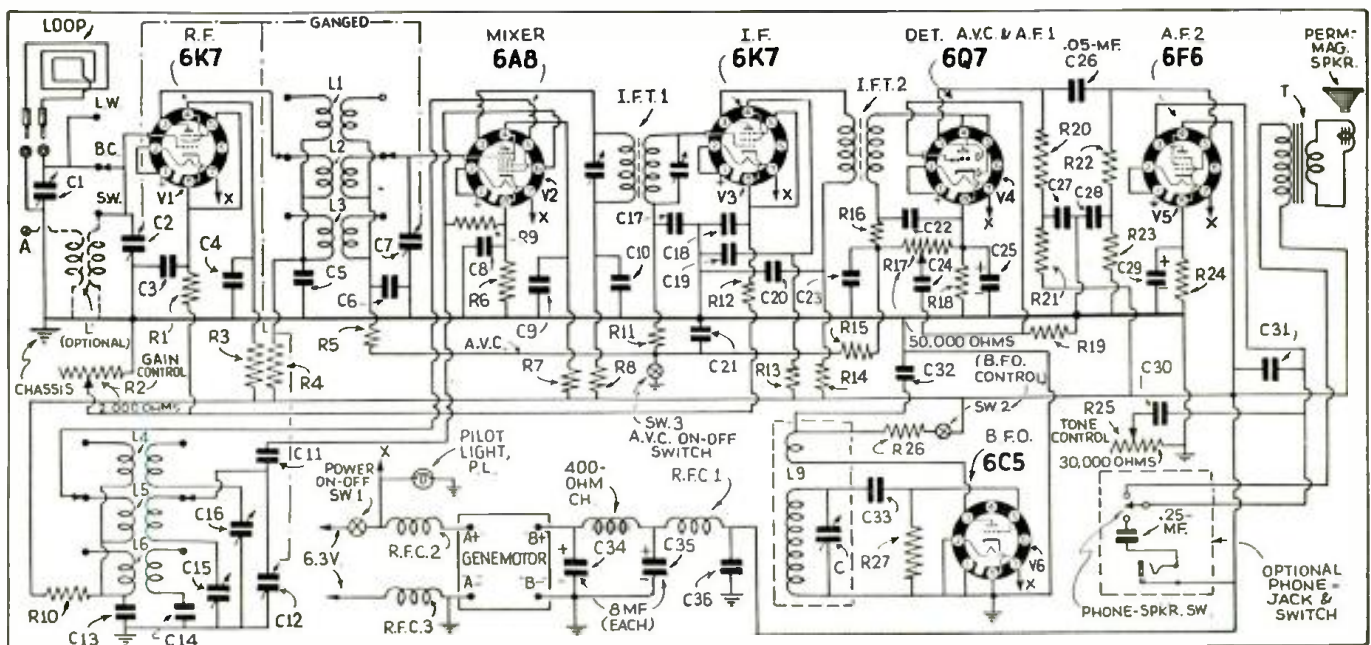

Fig. 1. Schematic circuit of "The Seafarer"—a standard, easy-to-build superhet. (The tuning "eye" is V7, shown on a separate diagram.)



THE ABC OF ELECTROLYTIC CONDENSERS

Although the electrolytic condenser is one of the most common components used in radio receivers and allied apparatus, little data concerning its construction and theory of operation are available in print. The discussion which follows gives you the "how" and "why" of the electrolytic condenser.

PAUL McKNIGHT DEELEY

FOR A LONG TIME, it has been known that several metals, such as aluminum, tantalum, niobium, magnesium, zirconium and titanium can be coated with an oxide film by electrochemical means. This can be accomplished by introducing the metal into a suitable electrolyte, for example, aluminum in an aqueous solution of boric acid and sodium borate, and passing a current through it, the metal forming the positive pole or *anode*. Upon electrolysis of the solution, oxygen is evolved at the positive pole which oxidizes the metal.

EFFECT OF OXIDE FILM

The thin film of oxide (Al_2O_3) formed on an aluminum surface offers a very high resistance to further passage of

current and if the applied voltage is kept constant, the current after a time, will be reduced to a minimum value, called the *leakage current*. A cell of this type with aluminum as the anode and an electrolyte as a negative electrode or cathode is used as a condenser, with the aluminum oxide film separating them, acting as a very thin dielectric.

The electrolytic condenser has a high capacity per unit volume as compared to other types of condensers. The thickness of the oxide film covering the aluminum electrode is very thin (approximately 10^{-5} cm.), and the dielectric constant K of the Al_2O_3 produced is high (approximately 10). Calculating the capacity C per sq. cm. from the above data we have:

$$C = \frac{K}{4\pi d} = \frac{10}{12.6 \times 10^{-5}} = 8 \times 10^4 \text{ cm.}$$

From this it can be seen that an aluminum electrode, of 100 sq. cm. surface, will produce a capacity of approximately 8 mf.

The electrolytic condenser can only be used with a flow of current in one direction. The aluminum electrode must therefore always be connected to the positive side of the applied voltage, and the electrolyte, (through the medium of the outer aluminum shell) must always be negative. With current flowing through the condenser in this direction, the current intensity is small. If the direction of current flow is reversed, a large current will flow through the

(Continued on page 171)

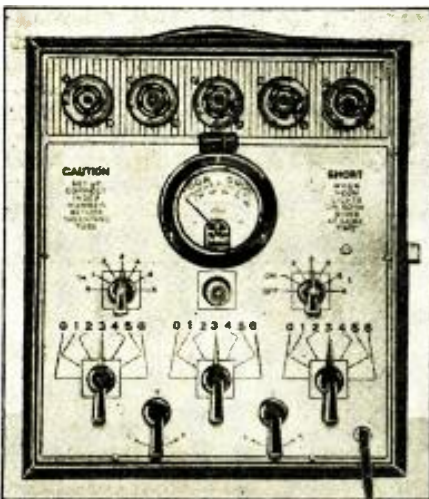

Fig. A. Appearance of "power level" tube tester.

DESPITE advanced designs in other equipment, tube tester design has remained practically the same. The following technical description outlines the basic features of an advanced system of testing tubes that depends on the fundamental electrical values of a tube, that is, (1) plate resistance, (2) amplification factor, and (3) transconductance.

THEORY OF THE "POWER LEVEL" TEST

The basic circuit is shown in Fig. 1. The circuit very closely resembles an amplifying system. The action is as follows: A voltage, E_g , is impressed on

THIS "POWER LEVEL" CHECKER MAKES DYNAMIC TUBE TESTS

The plate resistance, amplification factor and transconductance constitute a basis for testing all types of tubes.

H. HARRISON

the control-grid of the tube under test, a triode is shown for example.

Figure 2, a and b, shows the electrical circuit with respect to the plate of the tube. R_p is the plate resistance, R_1 is the load resistance, μE_g is the amplified grid voltage and E_p is the high voltage from the rectifier. The plate circuit meter, I_p , is a D.C. meter. There are however 2 voltages, neither of them D.C., in the plate circuit.

The graphical construction Fig. 3, a and b, shows how the average D.C. value of μE_g and E_p is obtained. The readings on the plate current meter therefore depend on (1) plate resistance, (2) amplification factor, and (3) transconductance.

The test is an overall one that takes cognizance of the dynamic characteristics of a tube.

HOW TESTS ARE MADE

Shunts are placed across the meter for various current ranges. Dual-purpose tubes such as duo-diode triodes, (Continued on page 170)

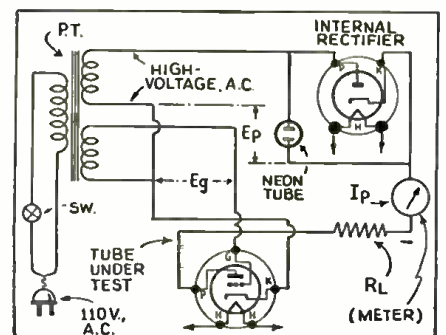

Fig. 1. The fundamental circuit used in the "power level" instrument for testing tubes.

BUSINESS PROBLEMS OF THE SERVICE MAN

An expert business consultant advises Radio-Craft readers.

Conducted by JACK GRAND



THE AMBITION of every radio Service Man I have ever come in contact with, was to open an "Ideal Radio Service Shop"; the place of business to be equipped with the best of modern service equipment, and to have an attractive appearance. With the equipment, he could turn out the type of work that would satisfy the most critical customer, and with the attractive appearance of the shop he could create the proper effect to promote confidence.

The embryo Service Man prepares himself by diligent study and practice, accumulates tools, test equipment, service manuals and other incidentals that he feels are necessary.

Time marches on, and the day finally arrives when he is ready to realize his great ambition. He is now ready to open up the "Ideal Radio Service Shop" that he has been planning all this time. He is prepared with everything *except business knowledge and experience!*

THE TRANSITIONAL PERIOD

It is a recognized fact that any number of excellent Service Men are very poor at conducting a business and I trust that the advice offered in this and succeeding articles will aid the newcomer to attain a greater degree of success in his chosen field of endeavor.

Fifteen years in the radio field has brought me into contact with men representing every branch of this great industry. I have met manufacturers, wholesalers, consumers, design engineers, broadcasters, and—the Service Man.

After listening to the opinions and experiences of the representatives of these various branches of the radio field, I find that every division of this industry, with the exception of radio service is well organized and on a sound business basis. Evidently, the methods used by these other branches are worthy of study, and I shall include some of their ideas and practices in the suggestions I will offer the Service Man.

The pitfalls of business are many, advice oftentimes misleading. Many Service Men make plans which to them appear to be sure-fire—just can't miss. In the enthusiasm of their ideas they do not see the fallacies—until too late.

There are no definite rules on how to become a successful Service Man, the "what to do" and "what not to do" stipulations that would help one man, may be the downfall of another. Therefore, I shall endeavor to select good average problems, explain them and analyze the best method of handling. In many cases the answer will be self-explanatory.

The radio service field is subdivided into a number of divisions, namely: (1) home radio, (2) auto radio, (3) public address, (4) movie sound, etc. We are primarily concerned with home- and auto-radio service as these two go hand-in-hand.

There are certain things that every Service Man has done or will do upon entering the service field. In order to

Job or Business

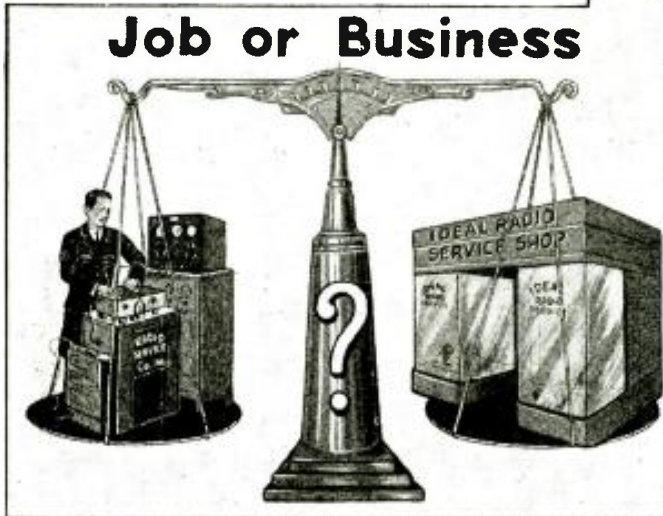

Every ambitious radio Service Man sometime considers the possibility of branching out "on his own"—either with or without assistants. If YOU are included in that group of Service Men who have only a limited amount of capital available and are uncertain as to the next steps to take, write to Mr. Grand (whose photo is reproduced at upper-right). "Jack"—as he prefers to be known—has helped thousands of other radio men and will be glad to personally advise you.

understand future problems a discussion of the elementary procedures is required.

As a rule the career of the Service Man starts from the home—generally from the kitchen table, a spare room, or a space in the cellar. So he repairs a few sets for friends or neighbors as a hobby. Then, as these people tell him how good his work is, and how he has repaired sets that others had given up, he decides that his future is radio servicing.

He may either attend a school, take a correspondence course, or acquire additional knowledge by reading technical books and trade magazines. After purchasing test equipment and having a quantity of cards printed, he feels

he is now "all set."

If, after having the cards printed, he passes them out carefully from house to house then dashes home, places the telephone within easy reach, adjusts the chair to the right angle, places his feet very carefully on the telephone table and waits for the calls to come in, he is sure to succeed—in going OUT of the radio business! The same results can be obtained by putting a nondescript advertisement in the local newspaper.

However, if after printing cards, he carefully places them in proper sources, and by continuous effort in trying to secure work for himself, locates defective radio sets, he has a good chance to succeed.

A TYPICAL PROBLEM

Recently, the following typical problem was presented to me. This fellow was a married man, employed by a large concern for the last 3 years, and received a salary of \$24 a week. He saw no opportunity for advancement in his vocation and decided that a change of occupation was necessary. Having had some electrical experience—he decided upon radio servicing as a medium for increasing his earning capacity. He decided to resign from his position and open a radio service shop. It was also decided that his wife would assist him by testing tubes and receiving phone calls while he was out of the shop on a repair or installation job. He felt confident that, with the assistance of his wife, he could succeed.

His home was in Brooklyn, New York, a section populated by people whose earning capacity was small. The store was to be opened in this section in view of the fact that he could secure a store with living quarters in the rear at a low rental—\$35 a month.

He was reticent to discuss his finances, but after convincing him that my advice was dependent to a great degree upon his financial status—he admitted that he had but \$300.

Let us analyze his problem:

The place of business was to be located in an out-of-the-way section in order to keep the overhead down.

(Continued on page 176)

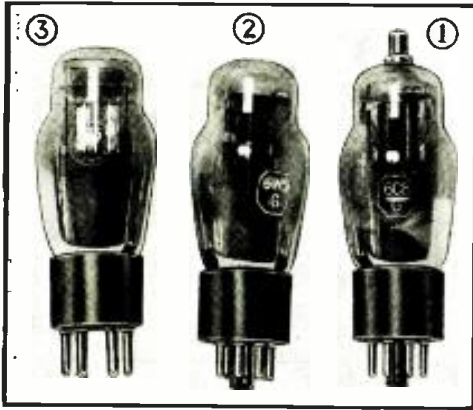

Fig. A. Three new tubes for the radio man; 1—6C8G; 2—6W5G; and, 3—6G5 6H5.

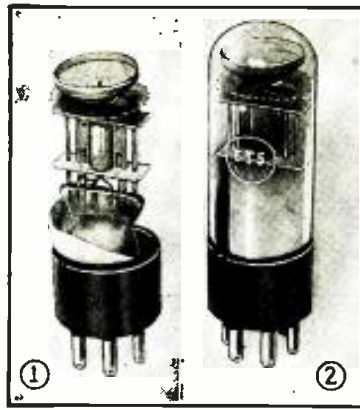

Fig. B. At 1—interior, and 2—exterior, 6T5 annular-pattern "eye."

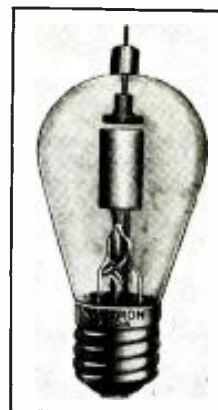

Fig. C. The 2-RA-6 mercury rectifier charger bulb.

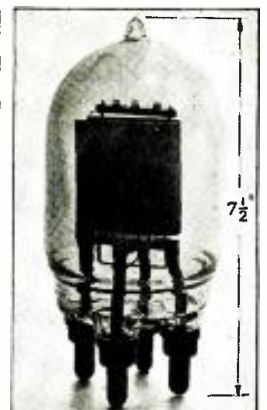

Fig. D. The WL-461 therapy and radio tube.

NEW TUBES FOR THE RADIO EXPERIMENTER

New amplifier, rectifier, tuning indicator, battery charger and ultra-shortwave therapy and radio tubes are briefly described.

PART I R. D. WASHBURNE

THIS COMPILATION of tube data has been prepared with a two-fold purpose in mind, first, to acquaint the reader with the more recent tube-types of importance to the general radio field; and second, to bring up-to-date the readers who have been following the descriptions given in past issues of Radio-Craft. For the latter reason, in part, the tube types to be described will be presented, under their several natural groupings, in their numerical order.

Space limitations preclude publishing the numerous and varied characteristics-graphs for the respective tubes; these graphs however are available from the manufacturers. In this Part are described only outstanding tube developments: forthcoming Parts will describe the remaining general run of new tubes under their classifications as Amplifiers, Rectifiers, Tuning Indicators and Special Service types.

The writer is indebted to the follow-

ing companies for their cooperation in supplying reference data for Part I: RCA Radiotron, Raytheon Production Corp., National Union Radio Corp., Hygrade-Sylvania, Continental Electric Co., and Westinghouse Elec. & Mfg. Co.

AMPLIFIER

6C8G (Glass) Twin Triode Voltage Amplifier. The triode units of this tube are independent of each other as the elements of this triode are brought out to separate prongs. Designed for service as a voltage amplifier or phase inverter. The voltage between heater and cathode should be kept as low as possible for they are not directly connected. Both triodes have been designed to match each other closely making it possible to build an inexpensive high-quality push-pull audio output system. The mechanical design is illustrated in Fig. 1. The overall appearance is shown in the photograph, Fig. A1.

Ratings		
Heater voltage	(A.C. or D.C.) 6.3 V.	
Heater current	0.3-A.	
Max. plate voltage	250 V.	
Direct Interelectrode Capacities		
	Triode L (triode R to cathode)	Triode R (triode L to cathode)
Grid-to-plate	2.5	2.4 mmf.
Input	3.4	2.5 mmf.
Output	3.5	3.9 mmf.
Grid-to-grid	0.1	
Plate-to-plate	1.5	
Amplifier—Class A—Each Triode		
Plate voltage	250	V.
Grid bias	-4.5	V.
Amplification factor	38	
Plate resistance	26,000	ohms
Transconductance	1,450	micromhos
Plate current	3.1	ma.
Phase Inverter		
Plate supply voltage	250	250 V.
Control-grid bias	-3	-3 V.
Plate current (per plate)	1.7	1 ma.
Plate resistor (per plate)	0.05-	0.1-megohm
Grid resistor (following tubes)	0.1-	0.5-megohm
Maximum output voltage r.m.s. (G to G)	60	80 V.
Cathode resistor	900	1,500 ohms

(Continued on page 188)

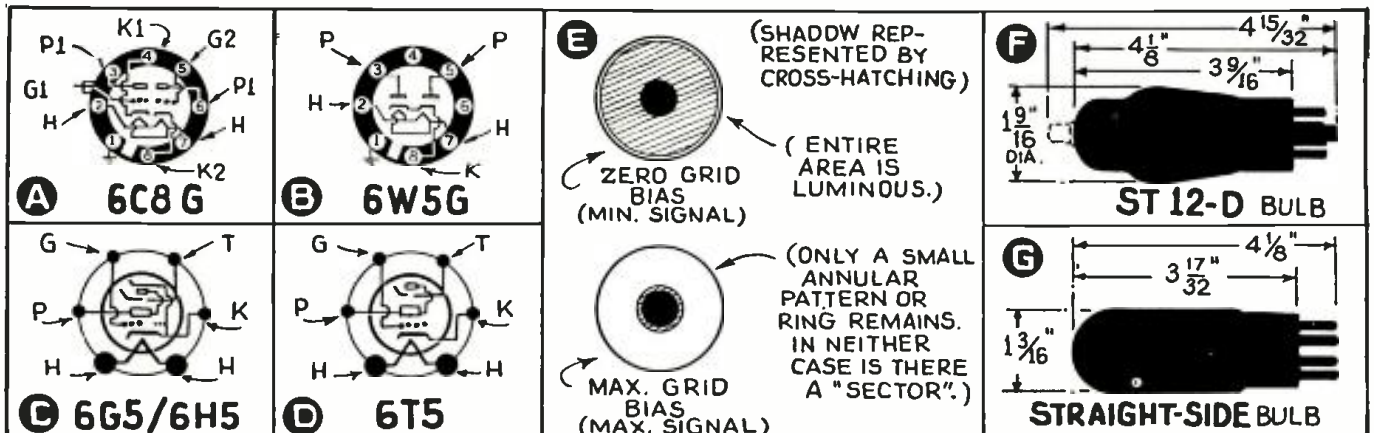

Fig. 1. Base connections and bulb styles of the various tube types described in the article.

THE "COLD CATHODE" GASEOUS RECTIFIER

A highly enlightening article on the theory of operation of the modern filamentless rectifier as exemplified by the type 0Z4 auto-radio rectifier.

H. F. ARGENTO

IT HAS been recognized for a long time that if 2 electrodes are placed in a fairly low gas pressure atmosphere, that some degree of A.C. rectification will occur, provided one of the electrodes is many times the area of the other.

As soon as sufficient voltage is applied between the 2 electrodes it will be noted that the electrode to which the negative end of the voltage source is terminated will develop a small glow around it. As the current from this 2-element device is increased, the glow surrounding the electrode with negative voltage on it, namely the *cathode*, will gradually increase until the cathode is completely covered. The voltage across the tube itself, known as the *voltage drop*, remains constant until such time as the cathode is completely covered with glow and once it is covered the drop increases very rapidly. By making one of the electrodes a very small fraction of the size of the other one, alternating current can be impressed between the electrodes and when the large electrode is acting as cathode a proportionately large current will flow and when the small electrode acts as cathode only a small current will flow.

The degree of rectification can be improved inasmuch as the value of cathode voltage drop depends largely on the

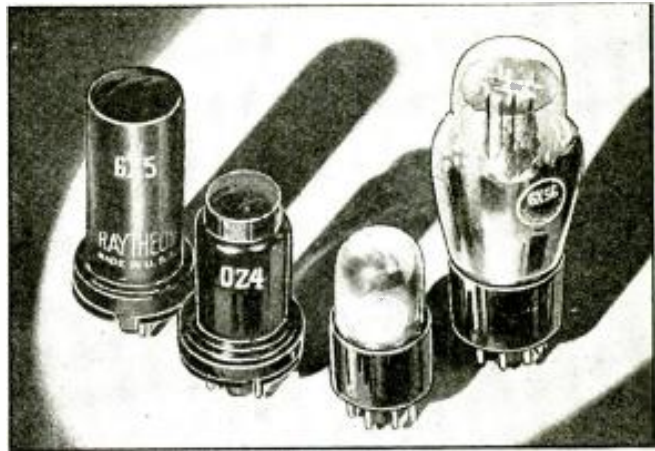

Several types of modern gaseous rectifiers.

electrode surface. By the use of various materials for electrodes and by proper processing, it is possible to greatly vary the value of voltage drop. By making the large electrode of such material as to have low voltage drop and the small one so as to have high drop a still greater degree of rectification can be achieved. The value of voltage drop at the 2 elements can be so widely different that efficient rectification takes place with electrodes of comparable dimensions.

COMMERCIAL APPLICATION

These 2 basic principles have been well known for a long time, but years of painstaking research and experimentation have been required to develop a satisfactory gas rectifier. One of the first commercial tubes applying these principles was the S type, followed by the well known BA, BH, and BR.

(Continued on page 179)

THE "H"-PAD OFFERS CONSTANT IMPEDANCE TO THE POWER SOURCE

The new "H" pad, comprised of only 3 variable and 4 fixed resistors, affords unusual flexibility.

W. H. FRITZ

A PRIME requisite for best performance of public-address equipment is that line impedances in the input and output circuits be maintained at a constant value. This relationship must hold throughout the range of volume, from zero to full output.

Change of volume with constant line impedance is accomplished with constant-impedance attenuators; "L" pads, "T" pads, and "Delta-T" pads are the types of attenuators most frequently used in this connection. In some cases, however, these pads will not perform satisfactorily. While they main-

tain constant impedance in a line, any of these pads can cause an electrical unbalance. Figure 1A shows how this can happen.

THEORETICAL ANALYSIS

Here two generators, each generating E volts, are inserted in the line as shown. In Fig. 1A balanced-type transformers are used, with center-tapped windings. While the generators have identical characteristics, the currents induced in each side of the line are not equal.

Actually, for the condition illustrated, I_1 is greater than I_2 , since resistance of the series legs of the "T" pad is in series with one side of the line. There is no resistance in series with the other side of the line. Identical conditions to those illustrated in Fig. 1A are found in practice.

The two generators can be replaced by an alternating field. This would induce currents in the same direction in both sides of the line. In the event that the generating source is a low-level microphone of the crystal or velocity type, the voltages induced by alternating fields can cause objectionable hum in the input to the amplifier. Figure 1B shows how this can occur. If I_1 differs from I_2 , there will be a hum component in the secondary of the input transformer. This arises from the voltages induced in each half of the transformer primary winding. When I_1 equals I_2 , the induced voltages are equal

(Continued on page 179)

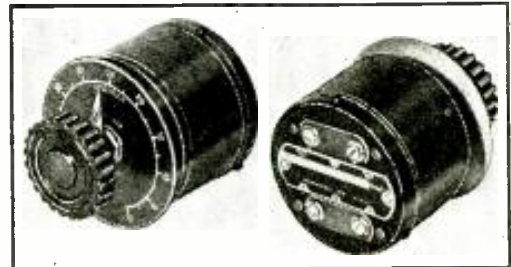

Fig. A. The new "H"-pad attenuator.

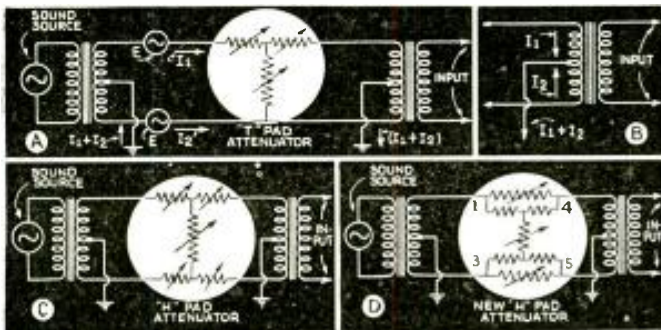

Fig. 1. A, the "T" pad causing unequal currents in a circuit; B, where the inequality occurs; C, expensive "H" pad; D, the new "H"-pad attenuator.



Fig. A. Note the small size of the "Open Road 3" battery portable set.

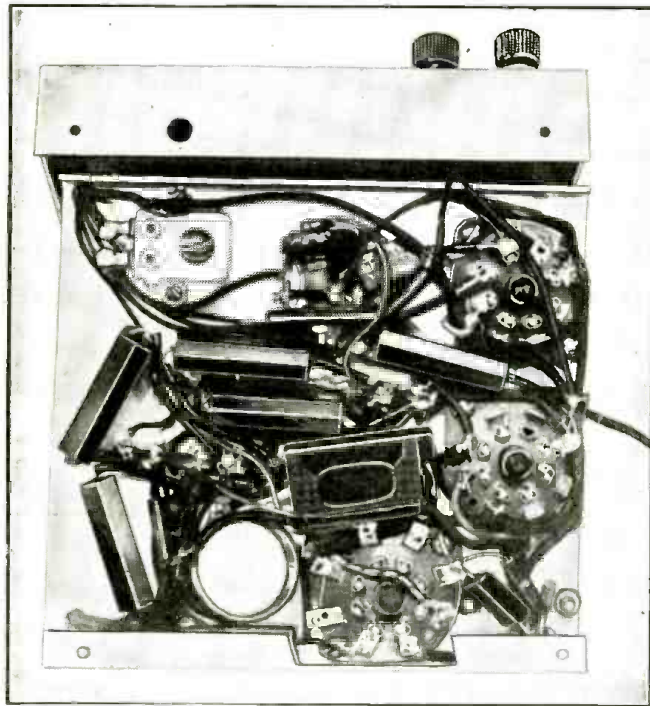

Fig. B. Under-chassis view showing wiring. The base is detached from the panel.

BUILD THE "OPEN ROAD 3" BATTERY PORTABLE RADIO RECEIVER

This is probably the smallest PRACTICAL portable "superhet." so far offered to set builders! It's sensitive, too.

H. G. McENTEE

THE WRITER has always been greatly interested in portable sets and has built a long series of them, starting in crystal detector days, and involving many different circuits. Up until recently the lack of small parts was a handicap—the battery situation being particularly "bad." Also, tubes and variable condensers were unnecessarily large, so that a good portable never was much smaller than an overnight traveling bag.

It is now possible, however, to purchase a set of components that will fit into a REALLY *small* case! The case used here measures only 5 3/4 x 6 x 9 1/4 ins. long, including the cover which, when shut, fully protects all the controls and the speaker. It would be possible to make the outfit considerably smaller by using smaller batteries, but this is both impractical and highly uneconomical. The batteries used will last about 30 hrs., if used on the basis of 3 hrs. per day. Naturally, the less they are used the greater will be their useful life. The "B" drain is only about 12 ma., while the filaments work well on 310 ma., although, if run at the rated 2V., the drain is 340 ma.

Build the Open Road 3 if you want to have radio reception wherever you go. The case is so small it will tuck into a corner of a suitcase almost without seeming to take up space. This is a fine set for use in rowboats, etc.; Service Men will find this radio receiver useful in demonstrating that certain forms of "static" and other peculiar effects are not due to outside conditions but are really caused by faulty operation of the customer's set; and, traveling men will find this set to be a real "companion." The Open Road 3 utilizes new, special-service, sturdy metal tubes.

DESIGN COMPROMISES

Of course, some compromises had to be made in design, the main one being the use of the new 1E7G tube. This consists of 2 pentodes in one shell, and is used for both 2nd-detector and A.F. amplifier. Since both screen-grids are run to one base pin it was necessary to use an A.F. choke through which to supply plate voltage to the 2nd-detector, as a resistance would have dropped the voltage so much

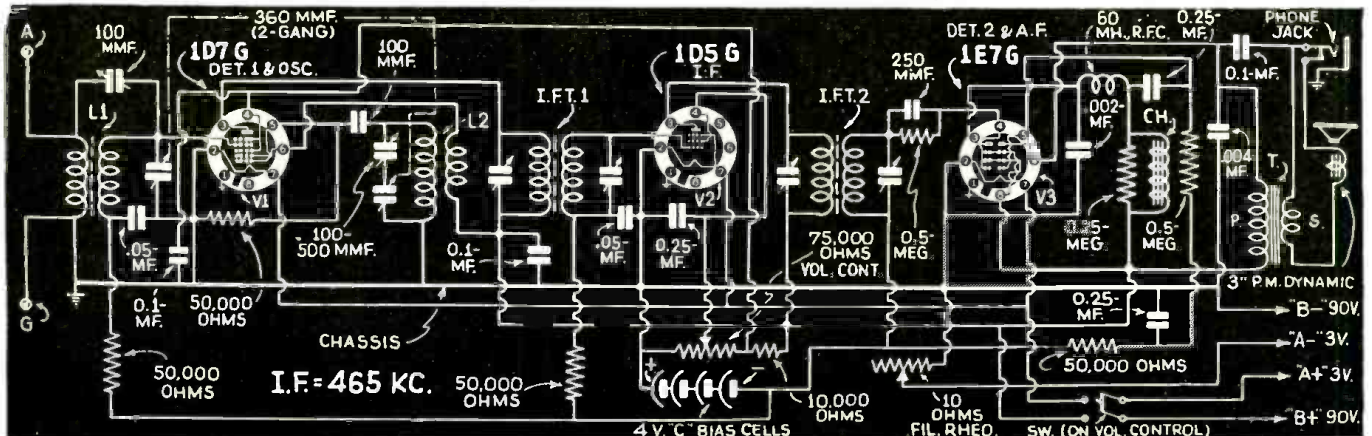

Fig. 1. Schematic diagram of the set. Note the simplicity of the circuit.

that a lower screen-grid voltage would be necessary, and this in turn would greatly reduce the efficiency of the output section. As finally arranged, both sections use full screen-grid voltage, and each section takes about 3.5 ma. plate current. The 2nd-detector section plate current might be cut down by application of more "C" bias but this would introduce complications. Naturally, with only 3.5 ma. plate current, the power output of the receiver is not very great. However it is quite sufficient to work the 3 in. P.M. dynamic reproducer at surprising volume and with good quality.

Another compromise will be found in the "C" battery, which comprises 4 grid-bias cells delivering about 4 V. altogether. This 4 V. is used on the control-grids of all tubes and while a little higher than needed, it serves to reduce the plate current somewhat from the value (about 17 ma.) obtained with 3 V. bias.

Every variable control needed for peak efficiency is provided. Thus we have (1) a *filament rheostat* on the panel, which is always set at the lowest value commensurate with efficient results. (2) The *volume control* (which also carries the dual power switch) controls screen-grid voltage to the 1D5G I.F. tube. Another panel control, not found in home receivers, is (3) the *R.F. trimmer*. This is a necessity because a variety of antennas will be used with the receiver, and a surprising increase in sensitivity will be had if the input-grid circuit is kept exactly in resonance.

PARTS LAYOUT AND CONSTRUCTION

The original set is housed in a commercial case, which is no longer available. This case was not quite deep enough so the panel was bent back on each edge so the whole assembly could protrude 1/2-in. from the case. If the case is made according to the specifications given, a simple flat panel may be used. A cover is not necessary but certainly protects the set when traveling. A slot 1 x 2 1/2 ins. long and covered with a fine copper screen is made diagonal to the speaker, in the case top. It acts as a sound vent to eliminate cavity resonance.

The builder is strongly urged to get all the parts together first and see that they fit a case of the size recommended, before the set is built. Tubes and other

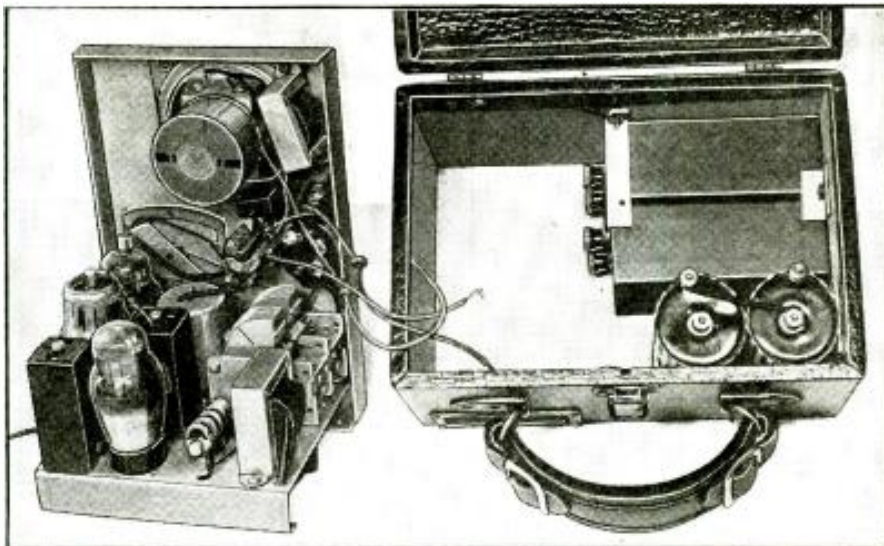

Fig. C. Rear view showing placement of parts. Note position of the batteries, which fit behind the speaker when chassis is in place. The sound vent may be seen underneath the left side of the handle.

parts, even if of the same type as those specified have been known to vary in size, and by making a careful check, a lot of grief will be saved if a certain part happens to be 1/4-in. larger than standard. Take a tip from the writer—*watch your step!*

The bias cells all fit in a single holder, but the latter must be cut down in size to fit on the chassis. This is a simple matter and consists only of putting the mounting brackets between the cell holders. *Be sure* to mount the cells as shown, with the cup shaped holder next to the tuning condenser. Another precaution! *Never* short the bias cells nor try to measure their voltage as this positively will ruin them. If properly treated they will never need replacement, but a current of even a few microamperes will completely spoil them.

A few slight changes are needed in the coils. The oscillator coil is removed from its shield, the shield cut down about 3/4-in. and the antenna coil mounted therein.

A small trimmer, found on the antenna coil, is removed, as the panel trimmer condenser takes its place. The control-grid lead, which comes from the top of one of the I.F. transformers is run down through the bottom of the transformer instead. This coil feeds the detector. The I.F. transformer used between tubes V1 and V2 is unaltered.

The wiring is a straightforward job

and needs no comment, other than that leads should be made as short and direct as possible. The control grid lead of the 1D5G should be shielded even though it is only a few inches long. No other shielding of leads is required.

CIRCUIT ALIGNMENT DATA

Alignment of the circuits is the same as in any other superhet. A test oscillator is of great help. The I.F. transformers are aligned first and the tuning circuits last.

Results are fine, even with a very short antenna and no ground. A 10-ft. piece of wire with a clip on one end is always carried with the set and is quite sufficient for local stations. It may be fastened to any metallic object, even a water pipe. The R.F. trimmer will be found quite sharp in tuning and of great help in bringing in weak stations. For DX work a pair of phones may be plugged into the panel jack; this will automatically cut out the speaker. With a fair antenna and ground connection, real DX results equal to those obtained with much larger receivers will be had. The iron-core coils used throughout undoubtedly contribute much to the fine performance of the receiver.

Again let us caution the constructor to gather together all parts and measure them for size before building the case. The writer speaks from sad experience on this important point.

(Continued on page 172)

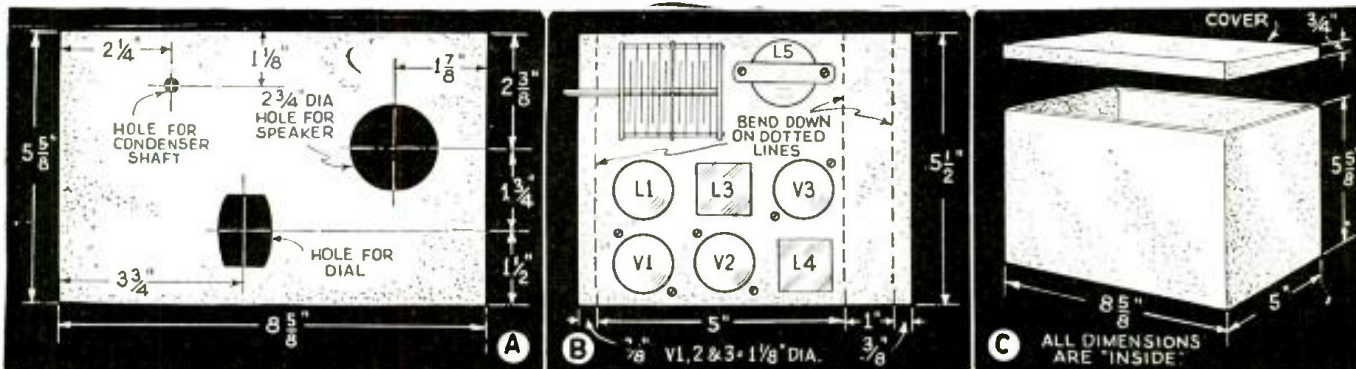
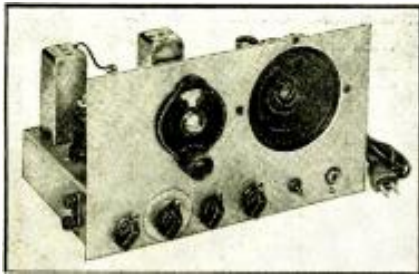

Fig. 2. A, panel layout; B, dimensions of base; C, specifications for case.



Front view of the low-cost superhet. receiver.

AN EASILY-BUILT SHORT-WAVE SUPERHET. "5"

A low-cost, 5-tube regenerative superheterodyne.

D. L. WARNER

HERE'S A LITTLE superhet. that really fills the bill for the amateur or experimenter who wants, or needs, a receiver capable of professional performance, but who has to limit himself, because of lack of money, to a small, inefficient set.

The set usually chosen in such a case is a 4 or 5 tube affair of the tuned radio frequency type, with a regenerative detector. While many distance records have been broken with such a receiver, the fact remains that the selectivity leaves much to be desired. Also, such sets are inclined to "block" on strong signals, spreading them over a considerable portion of the dial.

tubes, changing your signal to one of 456 kc. in frequency. It is then amplified
(Continued on page 178)

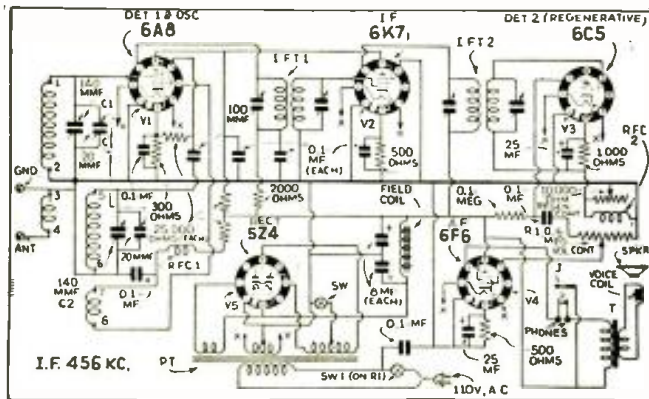
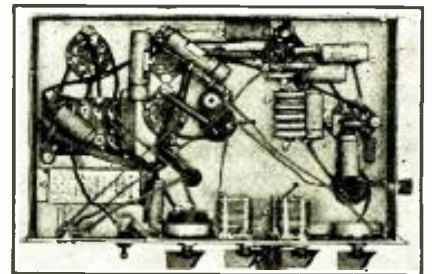
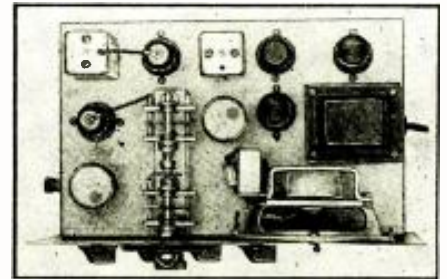

Fig. 1. Schematic diagram of the set. Note the regenerative 2nd detector.

CIRCUIT DETAILS

This little superheterodyne (see Fig. 1 for circuit diagram) was designed to be built for about the cost of a simple T.R.F. receiver, and is simple and easy to construct. Five tubes are made to perform as 8, in the following manner. First, the 6A8 converter tube performs as oscillator and modulator



Top and under-chassis view of the superhet. set.

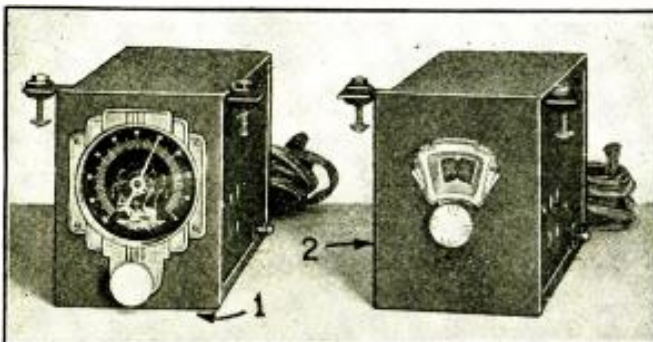

Fig. 1. Schematic diagram of the set. Note the regenerative 2nd-detector.

A NEW SHORT-WAVE CONVERTER FOR CAR RADIO SETS

A modern commercial design of converter, that beats Ol' Man Static, is illustrated and described.

C. O. PEEK

GOOD SHORT-WAVE reception in automobiles is made possible with any automobile radio receiver by attachment of either of the short-wave converters shown in Fig. A. The schematic circuit that is used in both is shown in Fig. 1; electrically, only the coils differ.

In each of these units 2 metal tubes are employed, one providing R.F. amplification of short-wave signals while the other supplies a signal which may be picked up by the radio receiver at an "intermediate frequency" of 600 to 700 kilocycles.

Wavebands available are as follows: unit shown in Fig. A1 (model 600 instrument)—covers 6 to 18 megacycles, and is suitable for short-wave reception of foreign broadcasts; Fig. A2 (model 500 instrument)—covers 1,600 to 6,000 kilocycles, and is suitable for Police, Airways and Amateur use.

In tropical climates where the heat-static makes reception on the broadcast bands practically impossible the unit shown makes satisfactory automobile radio short-wave reception in Fig. A1, covering the 49-31-25-19 and 16 meter bands, possible for the first time. With this unit a distance range of 6,000 to 12,000 miles may be accomplished.

The unit illustrated in Fig. A2 enables the use of standard auto-radio receivers for police work. The exceptional dis-

tance range of this converter makes it especially adapted to use of the police and other law enforcement officers.

Regular broadcast operation of the car-radio set is not affected when the converter is not in use. (The commercial make of converters here illustrated is designed for edge-of-instrument-panel, which makes them easy to install; and they have calibrated aeroplane and vernier dials that are easy to tune.)

This article has been prepared from data supplied by courtesy of ABC Radio Laboratories.

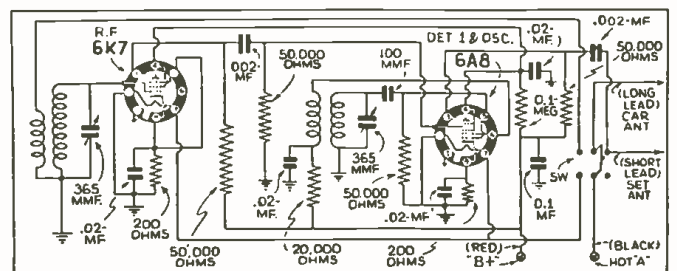

Fig. 1. Diagram of converters shown in Fig. A.

APPLICATION OF FEEDBACK TO A BEAM POWER AMPLIFIER

"Stabilized feedback" is the retroactive system employed in this amplifier. Sound men will appreciate this informative article. A special output transformer is used.

J. B. NICHOLS

CONSIDERABLE progress has been made in the past few years on methods of reducing (a) hum, (h) noise and (c) distortion in amplifier circuits, by feeding a portion of the energy from the output circuit back into the input circuit. *Stabilized feedback*—as this retroactive system is

called—is applicable in a number of ways, depending upon the actual application.

In power amplifiers, particularly those for P.A. service, the feedback is most important as applied to the output stage. The method used is to take a small percentage of the A.C. voltage in the output circuit and feed it back to the grid circuit. While stabilized feedback of this type will produce highly gratifying results, it is somewhat critical. A simple way of obtaining this effect is through the use of a tertiary winding on the output transformer. See Fig. 5.

The schematic of Fig. 1 (the power pack is Fig. 2) shows the application of such a winding (on T3) to a power amplifier using 6L6s in the output stage. The tertiary winding is designed with a ratio such that 10 per cent of the voltage developed across the primary winding is fed back to a 6L6 grid circuit. The degenerate connection of this tertiary winding back to the input transformer winding produces a number of effects:

- (1) Reduction in dynamic plate resistance of output tubes.
- (2) Approximately 50 per cent reduction in distortion.
- (3) Approximately 55 per cent reduction in power sensitivity.

(Continued on page 184)

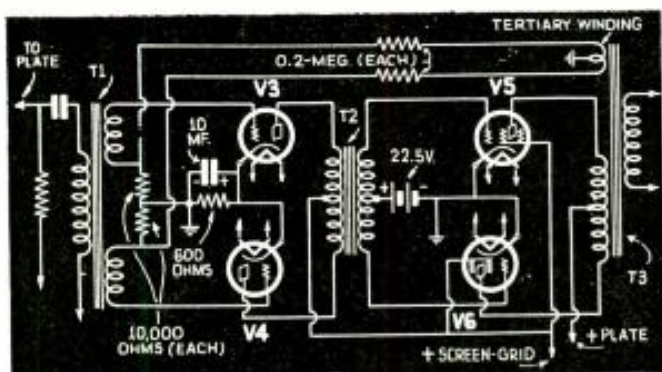

Fig. 5. The tertiary or third winding on T3 affords inductive pick-up of the feedback voltage.



Fig. A. Appearance of an amplifier with "stabilized feedback" system.

AN INEXPENSIVE DUAL RECORDING AND P.A. SYSTEM

A real money-making dual recording and public address high-quality system.

M. N. BEITMAN

THE GREAT forward strides made in the public address and recording fields have enabled the engineers to place on the market an inexpensive, high-quality recording system. This system, made up from carefully selected and matched components, proved so exceptional for its successful results and its simplicity of operation that it was felt *Radio-Craft* readers would be interested to study its circuit arrangement and other features.

Disc recording is the only practical method of *instantaneous recording* used at the present time. While either pre-grooved or blank discs may be successfully used, records of superior quality and better fidelity may be made on blank discs. Consequently, the recording equipment was selected to record on aluminum and composition blank discs.

THE RECORDING SYSTEM

Sound picked up by a high-quality crystal microphone is fed to a 15-W., high-gain amplifier. This amplifier operates on 105-120 V., 50-60 cycles. The amplifier, with other equipment of the system, may be used for play-back purpose and for public address application. See Fig. 1 for circuit diagram.

In the recording process, the output of the amplifier is fed to a recording head-in-arm of the screw-feed type.

A semi-professional recorder houses, in a sturdy oak



Fig. A. The complete dual recording and public address system.

case, the heavy-duty recording motor, recording head-in-arm, lead screw, play-back pickup arm, volume-level indication of the meter type, volume control, and "on-off" switch.

The essential equipment included in this system is listed below. It represents the simplest and the lowest-price system capable of making excellent records of the type that you will be proud to make and play for your friends and customers.

THE PUBLIC ADDRESS SYSTEM

A very important feature of the design of this recording and play-back system is that it is also easily adaptable for use as a powerful, high-quality public address system. It is at once apparent that the applications of a dual recording and public address system for both entertainment and money-making purposes are unlimited.

The market for recording is enormous and is growing steadily as people become familiar with successful results which are now inexpensively attainable. Orchestras are now being recorded, so that they can study and improve their technique. Students of music make records as a regular part of their training. Records are in demand for "sound effects" in radio and amateur theatrical productions.

(Continued on page 189)

OPERATING NOTES

ANALYSES of RADIO RECEIVER SYMPTOMS

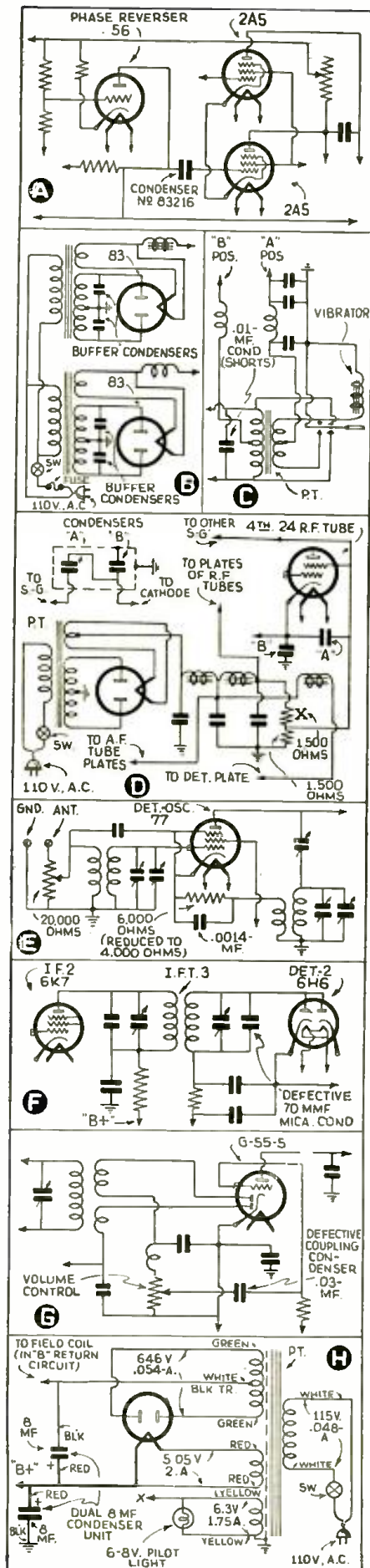

Fig. 1. Circuit details discussed.

Airline 07B, 32 Volt Farm Receiver. A scratching noise has been traced to the push-pull input transformer in several of these sets. Replacement is the only cure, for the noise is caused by electrolysis within the primary winding.

LEO E. BAER

Stewart-Warner R-120. The complaint was that this set had a steady whine and that it did not pick up short-wave reception. See Fig. 1A. Condenser No. 83216 (0.02-mf, 1,000 V.) open, caused the whine. A new 56 cleared up the short-wave reception.

Atwater Kent 812. The complaint was that the set smoked. This set uses 2 type 83 rectifiers and 2 power transformers. See Fig. 1B. Evidently this set had had a blown fuse, for some one had put a 20-A. auto fuse in place of a 3-ampere fuse. (This caused the power transformer to overheat. In this set there are 2 sets of buffer condensers mounted in one container. One of the buffer condensers was shorted out. This caused the 3-A. fuse to blow.) Replaced the blown buffer with 0.1-mf., 600 V. unit and replaced a 20-A. fuse with one having a 3-A. rating, which cleared up the trouble.

C. A. DAVIS

Philco 1937—620, 630, 640, 650, 9X. These models all have been serviced for one complaint, common to all—that of intermittent reception, wherein the volume level falls sharply, accompanied by resonance hiss. Where a shadowgraph is employed, the indication will widen. In some cases, the condition is not intermittent.

By connecting the aerial to the control-grid of the 6A8 or 6L7 (whichever tube may be employed as the 1st-detector), or placing a finger upon the control-grid, volume level becomes nearly normal and the resonance hiss clears up to a great extent. This procedure would, quite naturally, indicate the trouble to lie within the R.F. stage, and such is the case. However, a volt-ohmmeter or analyzer will not point to the difficulty, which is a snapped lead, from the stator lug of the R.F. section of the gang condenser to a lug on the wave-band switch, at the wave-band switch lug. It is quite unnecessary to remove the assembly to resolder this lead if the soldering tip is only $\frac{3}{16}$ -in. in dia. and at least 2 ins. or slightly less in length. The complaint of hum, which is still present with the rectifier tube removed from its socket may often be remedied by tightening the assembly and mounting bolts and nuts of the power transformer; otherwise, replacement of the transformer becomes necessary.

Philco 1936 Receiver Volume Controls. A constant source of trouble with almost all 1936 Philco receivers has been noisy and intermittent operation of the volume controls. In the majority of cases, replacement has been unnecessary. A light steel wire wound once around the shaft (and the ends twisted) between the soft "U" washer and bushing on the shaft, to remove the end play, has proven very effective and satisfactory. To complete the repair, place a drop of oil upon these parts to prevent excessive wear of the steel wire, washer or bushing.

RCA Victor 28-P. When the complaint of intermittent reception is received, wherein the volume level suddenly decreases sharply and returns abruptly after some interval of operation, check the detector secondary-return bypass condenser for an open-circuiting condition. Unlike many similar failures, striking the condenser seldom discloses any defects, although switching the receiver on and off quickly will bring up the volume level. In some instances, the switching of a room light off or on will produce the same effect. The open-circuiting of the R.F. cathode bypass condenser has been found to cause the same trouble although the decrease in volume is not as great as that ex-

perienced when the detector (2nd) secondary-return bypass condenser open-circuits.

Upon the appearance of oscillation and strong motorboating, most likely the second section of the dual dry electrolytic filter block is at fault because of a loss in capacity. The block may either be replaced or the defective section disconnected and an external condenser substituted.

BERTRAM M. FREEB

Crosley Model 102. Inoperative due to 0.01-mf. condenser which is connected across secondary winding of power transformer, becoming shorted. See Fig. 1C. Replace with a 600-V. unit. Access to this condenser may be had by removing end plate opposite control side.

Another cause for no reception may be due to the metal cover touching the terminal of the lead from the grid of the I.F. tube. This terminal is attached to the frame but is insulated from same by means of a mica strip. When the cover is removed, the receiver will operate under this condition. Terminal may be bent to position to clear cover. Care must be used in removing the cover of this set, as the loud speaker is mounted on the cover, and connecting leads are short, thus allowing leads to be easily torn from terminals.

Intermittent reception on this model has been found to be caused by breaking of the flexible lead from the R.F. transformer to the gang condenser at the point where a soldered connection is made to the condenser, as the gang condenser is mounted on rubber and is permitted some movement.

Detrola, Warwick Model. Inoperative over part of broadcast band. This condition has been remedied by replacing the voltage-dropping resistor for the screen-grid of the type 57 detector-oscillator tube, with one of lower value. The original resistor is 50,000 ohms and may be replaced with one of 40,000 ohms.

Columbia Radio Corporation, Model SG-9. Lack of reception is often found to be due to an open 1,500-ohm section of candohm resistor; this is marked X, in Fig. 1D. A condition reported as "weak and distorted" was found to be due to a leaky condenser, connected from screen-grid of the 4th type 24 R.F. tube to the common cathode-return lead. This is condenser A on the diagram. This condenser and condenser B are connected inside the condenser can as shown in the illustration.

HOWARD J. SURREY

International "Kadette" 4-Tube Set. Out of 11 service jobs on the 4-tube Kadette receiver, 10 of the sets called for the replacement of the double 5-mf. electrolytic condenser used as a bypass across the cathode resistors of the type 36 and 34 tube. The life of this very compact condenser is somewhat shortened by the heat produced in the filament series resistor located beneath the chassis at the back. It is an excellent idea to cut out this resistor and replace with the conventional line-cord resistor made for 4-tube sets. A wiring diagram of this set appeared in the February 1933 issue of *Radio-Craft*.

E. I. DEETER

Philco 84. We had a Philco 84 in the shop. The complaint was "intermittent reception." I turned the set on and checked everything that was suspected. Everything tested "normal," including the voltages. Then the set popped on and played the rest of the day, but the next morning it would not play. After having been turned on about 30 mins. without results, it suddenly popped on and played all day satisfactorily. This kept up for 2 or 3 days. Then I got out my diagram and started using a little theory. From the cathode of the detector-oscillator tube there is a 6000-ohm resistor connected through the primary of the oscillator

NOTICE

Contributors to this department should submit only Operating Notes that discuss recurrent receiver faults; those which have occurred only once or twice cannot be considered characteristic of a particular set model. Accompanying Operating Notes by sketches.

coil to ground. (See Fig. 1E.) I replaced this resistor with a 4000-ohm unit and this cured the trouble completely. The value 6000 ohms. of this resistor was too high and was causing the tube to block.

JAMES W. TAYLOR

Sparton 930-931. Howling, oscillation and motorboating in warming up may be due to an open secondary winding in one of the R.F. transformers. These receivers have this tendency after being in service for several years. Upon advancing or retarding the volume control, the set may also cut off sharply. After about 3 mins. of warming up the receiver seems to operate OK even with an open secondary in one of the R.F. transformers, which is misleading.

D. R. BITTERMAN

Midwest 18-36. When a periodic drop in volume was noticed in this set, it was at first blamed on a 6D6 tube which showed "shorted" in the tube checker when lightly tapped. The tube was replaced and the set played for a final check and the fault appeared to be corrected, but after a short time in the owner's home the trouble again appeared. It was finally located in a faulty mica condenser located inside the last I.F. coil.

This small condenser (75 mmf.) was in parallel with the secondary trimmer of this coil and at intervals would open-circuit, which would detune the I.F. stage. The trouble was corrected by removing the trimmer from the circuit entirely as the maximum capacity of the trimmer proved to be high enough to trim properly.

The cause of the trouble appeared to be due to the fact that the leads to this condenser were clipped and soldered very short and when the hot iron and rosin core solder were applied, they weakened the connection inside the condenser. We later received another Midwest with the same trouble.

T. A. HILDEBRAND

Midwest Metal-Tube All-Wave Set. Had one of these multi-tube sets in for service. Complaint—"no reception." All tubes were checked and found OK. Also, all voltages checked normal. Each and every condenser in the set was checked and found OK. While poking around in search of an idea, I happened to touch the grid of the 6K7 osc.—1st-det. Received a high-voltage shock! On examining the all-wave coil assembly I found that all the leads of the coils were in close proximity and very lightly insulated. It became apparent that it was here that the high voltage was shorting to the grid of the 6K7. By turning out all the lights in the shop and peering closely into the coil assembly it was possible to detect a faint spark at the point where the short was occurring. When the lights were turned on it was possible to clear the trouble with a prod, by pushing the wires apart.

We have used this method for locating shorts between wires, quickly and accurately on several occasions and find it highly successful. The operation is further facilitated by agitating the set slightly while looking for the spark.

M. J. MILLER

RCA Model 80. The complaint was poor sensitivity from 900 kc. to 550 kc. I found, in trying to align the tuning stages, that I could get a normal response at 1500 kc. when aligned at that frequency, but when trying to align at 600 kc. found sensitivity to be very poor unless a great change in alignment was made. It looked very much as if the 600 kc. oscillator trimmer condenser had too much capacity. This condenser looked and tested apparently OK, but on replacing with new one found the set worked OK.

E. C. BURR

Crosley "Repose, Jr." The set came in with a complaint of "too loud a hum." When the set

was turned on it was found that the hum was almost as loud as the program being received. All tubes tested perfect and voltage and resistance analysis indicated that everything seemed to be OK. According to the customer, this set had been in for repairs before, with another Service Man, for the same complaint. Finally, I looked for some signs to indicate where the former repair had been made. Eventually I found these signs pointing to the 8-16 mf. dual condenser. Accordingly, this unit was disconnected and tested and found to test OK, so it was returned to the set and still the hum was there, with apparently nothing wrong with any of the units.

As a last resort, it was thought that the filter choke may have had shorted turns which would act as an autotransformer with part of the winding shorted, therefore reducing the inductance. It was while tracing the circuit with the ohmmeter to locate the choke coil leads that a condenser effect was observed between the wires which had just been disconnected from the filter choke.

These wires were traced and found to lead one to each of the negative ends of the double condenser. This unit was again removed and another test made, this time testing between the two negative leads of the dual condenser unit. Lo and behold! A true electrolytic condenser characteristic was observed between the sections. Thus, when connected across the choke, a "third condenser" was connected directly across the choke and, as far as its inductance was concerned, shorted out. An ohmmeter test would not locate this fault due to its high ohmic value. The faulty unit was removed and replaced by two separate units strapped together and mounted in its place. The hum disappeared.

M. J. JEUNE

Majestic Model 461A. On high volume, the set would intermittently drop in volume with accompanying distortion. And when the volume control was turned to the extreme-low-volume position the station signal could still be heard. If set resumed normal operation, the signal would disappear at the low volume setting. The trouble was found to be the 0.03-mf. coupling condenser connected from the moving arm of the volume control potentiometer to the control grid of the 55 tube. (See Fig. 1G.) The above condenser is in a block. A new single unit 0.03 mf. condenser was installed and the trouble was cured.

ALFRED F. SPAIGNI

Silver-Marshall 30. The complaint was bad distortion and weak volume. A check-up showed that the 45s were drawing heavy plate current. This indicated lack of "C"-bias and, upon investigation, showed the speaker field coil was open. This coil is used to obtain the "C"-bias on the 45s. Do not hesitate to open the speaker because, invariably, the "open" is right at the outside connection of the coil and it is no trouble at all to remedy.

M. E. CAGLEY

Grunow Model 460 (also Models 450 and 470). If set is completely "dead", with no voltages on any tubes, you can usually trace the fault to the dual 8-mf. electrolytic condenser shown in Fig. 21. When replacing this unit, use a high-grade unit or a unit with low leakage or it will not last. If a cheap condenser is used, the set will play perfectly for about 2 hrs. and then, look out for trouble! This also applies to models 450 and 470, as they are subject to the same trouble.

W. H. DEERING

Philco 87. The set came in with complaint of "static" and "frying noises" at intervals. Resistors, tubes, etc., were checked and, after hours of sweating, I found by shorting out the plate side of the audio transformer for a mere second, the noise became louder, then cut off, and then repeated. This is also a good test for resistors, chokes, etc. A new transformer was installed and the set was trouble-free again.

Majestic 100B-90B. Weak reception, signals fading entirely after a few minutes' operation. Holding my hand close to the 1st R.F. tube, I found signals returned with normal volume. Tests showed that the 0.001-mf. in the antenna stage was completely shorted. This condenser is easier tested by unsoldering. A new condenser

(Continued on page 191)

SERVICING QUESTIONS & ANSWERS

Service Man may write, requesting answers to specific service questions. Address inquiries to Service Editor. For questions answered by mail, a service fee of 25c per question is made. AN EFFORT IS BEING MADE TO MAINTAIN 48-HOUR SERVICE IN HANDLING THIS MAIL.

NO VOLUME

(21) Samuel Rosen, New York City:

[Q.] I have a Grunow model 11:1 all-wave receiver which operated satisfactorily until a few weeks ago, when the volume suddenly dropped. I am unable to raise the volume even though I advance the control to the maximum position. Please tell me how to correct this fault. Incidentally, the tuning "eye" seems to function properly.

[A.] This fault can easily be remedied by replacing the 68,000-ohm plate resistor of the 6C5 audio tube, which opens. See Fig. Q.21 (right). Your statement that the visual tuning indicator functions properly, conclusively indicates that the trouble lies in one of the A.F. stages.

NOISE BETWEEN STATIONS

(22) William Smith, Fort Worth, Texas:

[Q.] I have recently purchased a G.E. model E86 receiver and have a great deal of noise when tuning from station to station, although this noise is not present when the station is tuned-in properly. Please advise me what to do to correct this condition if it is at all possible.

[A.] A method that will minimize noise between stations was discussed in the June 1937 issue of *Radio-Craft*, Operating Notes department. However, we will repeat it for your benefit. Examine the under side of your chassis, particularly the 2,200-ohm cathode resistor of the 6K7 first I.F. tube. Remove this resistor and substitute a 10,000-ohm unit in its place. Further, remove the R.F. cathode wire running to ground and shunt it to this 10,000-ohm resistor. Doing this will retard the A.V.C. action until this added bias is overcome by the signal voltage which must reach a designated level before any diode current flows. See Fig. Q.21 (left).

COLORAMA LIGHTS CONTINUALLY "BLOW"

(23) David Wisotsky, Brooklyn, New York:

[Q.] I am troubled with pilot bulbs continually blowing out on my G.E. model E155 receiver. How can I remedy this condition?

[A.] Of late this same question has been asked by many owners of this same model receiver. Remove the chassis, making sure to pull out the speaker plug first to prevent snapping the leads. You will notice that there are a red and a black wire connected to the bank of pilot bulbs. Unsolder the black lead and insert a 1-ohm resistor in series with it. This will prolong the life of these bulbs.

(Continued on page 191)

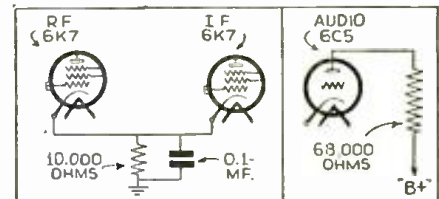

Fig. Q.21. Left, G.E. E86; right, Grunow 1191.

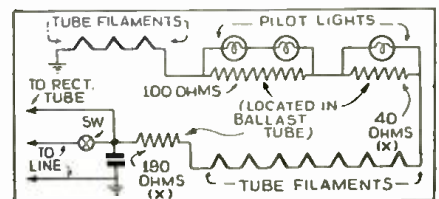

Fig. Q.24. A "dead" Fada set repair.

HOW TO MAKE AN A.C.-D.C. INTERPHONE USING ONLY 1 TUBE!

An ultra-simple wire-type intercommunication unit. Designed by the author, in collaboration with R. D. Washburne, and built to prove that "it could be done"!

ARTHUR BLUMENFELD

THE OUTSTANDING feature of this inter-office communicator is its simple and foolproof design. The use of a design in which only 1 tube is necessary in each station, results in a unit of small size and few parts. Only 2 resistors are used in each unit!

ADVANTAGES OF "DIVIDED GAIN"

The construction of the unit is very simple, due not only to the few parts necessary but also to the stability of the design. The use of "divided gain" eliminates the possibility of oscillation which is often encountered in the high-gain type of intercommunicators. The 1-tube interphone also has other advantages over the usual type of system. The use of "divided gain" makes possible the calling of an unlimited number of stations without loss of either power or clarity. There are also unlimited possibilities as to multi-station break-in. That is, any group of stations may hold a conference without

the use of additional switches, such as are necessary with the usual systems.

In order to understand the principle of operation of the 1-tube intercommunicating system, examine the 2-station type which is shown in simplified block diagram form in Fig. 1.

In Fig. 1A station No. 1 and No. 2 are shown in the "stand-by" position ready to receive messages from each other. In Fig. 1B station No. 1 has thrown its switch to the send position and is talking to station No. 2. When station No. 1 releases the switch, both stations are again in stand-by position and station No. 2 talks to station No. 1 as shown in Fig. 1C. Notice that during transmission, the 2 amplifiers are in cascade in order to give the required amount of amplification. The total amount of gain is "divided" equally between the 2 stations.

The total gain of the entire system is about 70 db. With the usual type of intercommunicator, to attempt to build a compact unit results in a design which is quite critical as to circuit oscillation. Any slight deviation from the original design in regard to placement of parts or method of wiring, may result in uncontrollable oscillation. However, by dividing the gain equally between the units, we have only 35 db. gain to contend with. It is practically impossible to run into any trouble, no matter what the arrangement of parts. The method of wiring is also not critical, as long as the circuit is followed correctly.

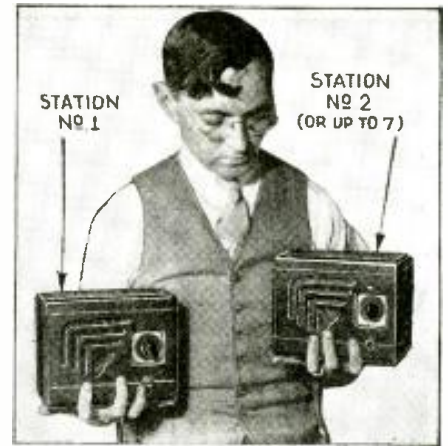

Fig. A. Note convenient size of these communicators. Any number of these units (stations) may be used.

It might be mentioned also that there are some disadvantages in the simplified system of the 1-tube intercommunicator. There is a slight hum when transmitting, due to the use of a power-type tube as the first tube in the amplifier. However this slight hum does not interfere with the clarity of the speech, and is not annoying. In the "stand-by" position the units are silent, without any background noise.

CIRCUIT ANALYSIS

The schematic circuit of a single unit of a 2-station system is shown in Fig. 2A. In installing the system, a 2-wire cable (with plug and socket connections) is run from one unit to the other. Each unit uses a 12A7 type tube which consists of a half-wave rectifier and a high-gain power pentode.

Note that the rectifier system does not use a choke for filtering. The 2,000-ohm resistor, R2, provides adequate filtering without causing excessive voltage drop. This is due to the fact that the 12A7 draws only 15 ma.

Switch Sw.1 is a double-pole double-throw unit of the press-to-talk type. This means that it should contain a spring to return it to the "listen" position. Of course an ordinary D.P.D.T. toggle switch may be used, but this is more difficult to manipulate than the spring-return type.

Input transformer T1 is designed to feed from a 4-ohm line into a control-grid. The output transformer, T2, is of the universal type with the full wind-

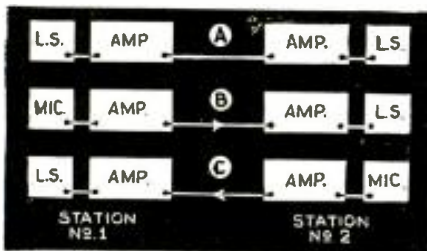

Fig. 1. Status of units when (a) "standing by"; (b) talking and (c) listening.

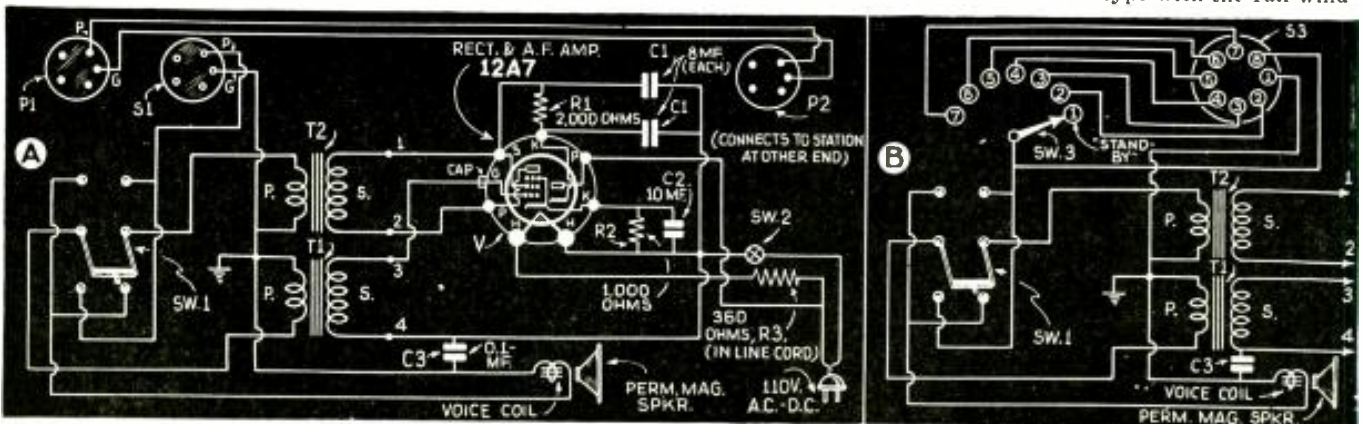

Fig. 2. A, diagram for 2-station system; B, for multi-station system.

ing used as primary and taps 2 and 5 for the 4-ohm secondary. By shifting the taps of this output transformer, variations in tone may be effected. In general, however, the 2 and 5 taps will be found best.

The bias for the 12A7 is obtained from the voltage drop across a 1,000-ohm resistor, R2, shunted by condenser C2 which is a 10-mf. electrolytic. Note that the "B"-minus return does not ground directly to the chassis, but is connected to a 0.1-mf. condenser, C3, which goes to the chassis. This serves to isolate the power line from the 4-ohm voice line. The resistor, R3, situated in the line cord, is 360 ohms. The speaker is a 3-in. P.M. (permanent-magnet) dynamic type. Switch Sw.2 is a single-pole single-throw rotary switch.

7-STATION SELECTIVE OPERATION

When more than 2 stations are necessary, the circuit of Fig. 2B should be used. An examination of this circuit shows that a 7-point switch, Sw.3, has been added. Also an octal-type socket has been substituted for the 5-prong socket. We can now install 7 of these units as a selective-type intercommunicator. The 7-point switch allows us to select any one of the other 6 stations with the last point used as an "off" or "stand-by" position.

The complete interconnecting wiring diagram of the 7-station intercommunicating system is shown in Fig. 3. The materials required consist of an 8-wire color-coded cable (of sufficient length to pass through all the rooms in which the stations are to be installed), and 7 octal-type plugs.

The best method is to install the cable all in one piece, allowing about a foot of slack at the points near where the units are to be installed. If splicing is necessary, the cable color code indicates the proper connections. If the colors of the cable do not correspond to those of Fig. 3, the correct colors must be noted on the diagram in order to prevent confusion.

The 7 octal plugs Pa, Pb, Pe, etc., of Fig. 3 are connected to adequate lengths of 8-wire cable as shown. The color code of all should be identical and are to correspond to that of the main

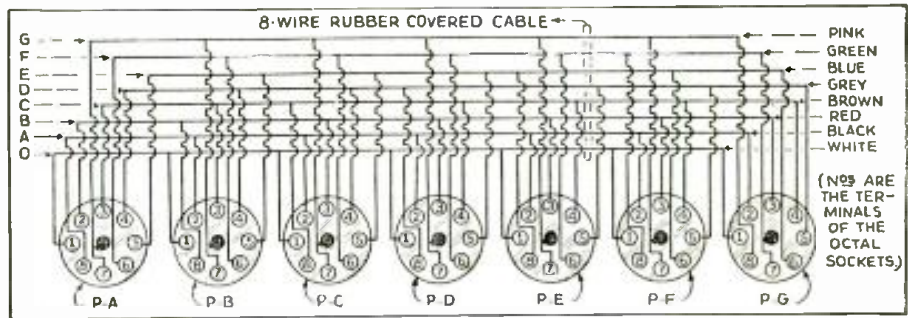

Fig. 3. Circuit for either selective and semi-private, or (position "O") "conference" communication.

cable to which the plugs connect. In connecting the plug cables to the main cable, simply skin back the wires, make the proper connection (solder all connections), and tape each individually. These connections are made at the points where slack was left in installing the cable. For the sake of appearance the cable junction should be covered with a small box. Note that plugs Pa and Pg may be connected directly to the ends of the main cable. The next step is to insert the 7 plugs into their respective units and plug the line cords of the units into the A.C. or D.C. line. The system is now ready for operation.

The indication of the outlying stations on each unit may be made by studying Fig. 2 and Fig. 3. Thus on station "A", the pointer knob of switch Sw.3 indicates as follows:

- Point No. 1....."off" or "stand-by"
- 2.....to station "B"
- 3.....to station "C"
- 4.....to station "D"
- 6.....to station "E"
- 7.....to station "F"

The dial markings of station "B" are similar, except that point No. 2 indicates station "A" instead of "B", etc. The operation of the system is as follows: All stations are normally on point No. 1 or "stand-by". If station "A" wishes to call station "B", the knob of Sw.3 is thrown to "B" position and Sw.1 pressed for the "call" position. When station "A" is finished talking, station "B" need only press Sw.1 in order to answer. This feature of the system saves much time because in the usual interphone, station "B" would have to know from what station the call had originated in order to reply.

THE "CONFERENCE" CIRCUIT

If station "A" wishes to have a conference with stations "B" and "C" simultaneously, he calls them each individually and asks them to get on his line. A 3-sided conversation is then possible. This may be also arranged for any number of stations. Even while talking to all 6 outlying stations there is no loss in either volume or quality. This is due to the design whereby the voice is transmitted to a load which absorbs a very small amount of power. In the usual type of intercommunicator, the power delivered is in inverse ratio to the number of speakers on the line.

While the system described was for 7 stations, any number of stations may be arranged-for by means of slight changes. For instance, if a 3-station system is desired, only a 4-wire cable between stations is necessary. Only that portion of Fig. 3 which includes Pa, Pb, Pc, need be used. For more than

(Continued on page 167)

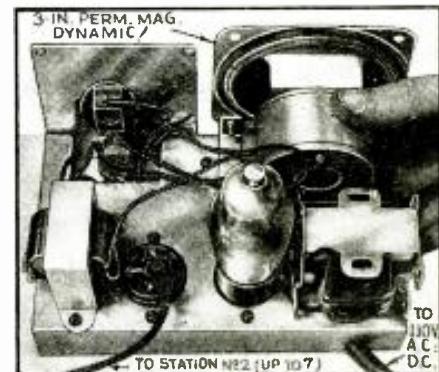

Fig. 8. Rear view showing placement of parts.

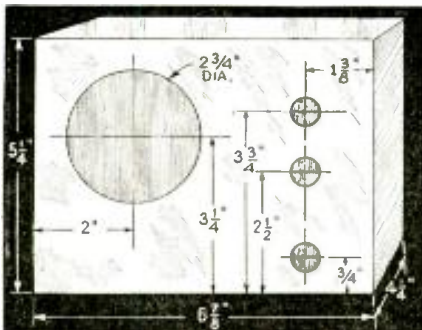

Fig. 5. Front-panel drilling layout of the I-Tube Interphone. (Radio-Craft has originated many ideas that later found their way into commercial production, but, it is felt that no instrument so far offered will create quite the furor and arouse as much interest among equipment builders, and be as widely copied, as this I-Tube Interphone.)

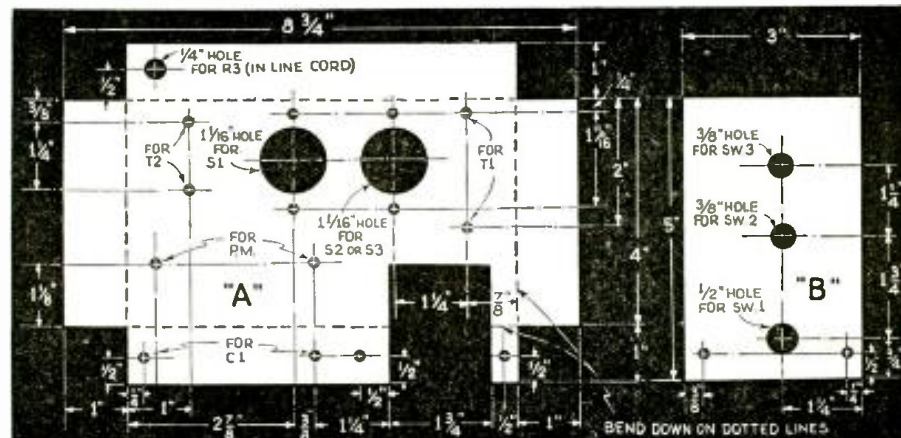
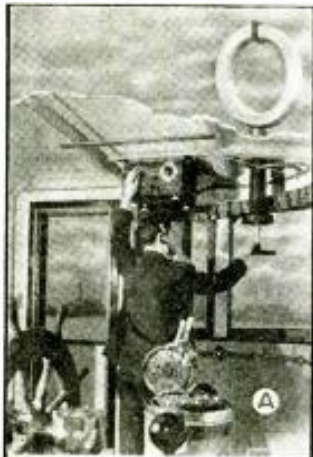

Fig. 4. Chassis details of the I-Tube Interphone. This is a money-maker for Service Men.

THE LATEST RADIO EQUIPMENT

This department brings to you each month the newest developments in electronic, radio and public-address equipment. Aggressive technicians use this department to keep posted on the newer and better ways of doing things.



RADIO DIRECTION FINDER FOR SMALL BOATS (1449)

(The Radiomarine Corp.)

ILLUSTRATED here are 2 views of the type AR8702 table-model radio direction finder designed for use on pleasure craft and small fishing boats.

The receiver is a single-dial, 7-tube superhet, having high selectivity and sensitivity for reception of low-power radio beacons recently made available by the U.S. Bureau of Lighthouses. Bearing scale is read in degrees through a magnifying glass and is dimly illuminated so that bearings may easily be read at night without producing glare.

MULTI-FEATURE PORTABLE AMPLIFIER (1450)

(Operadio Mfg. Co.)

THIS amplifier is described as being of base or semi-portable type. The output is 55 to 80 W., obtained from a 6-stage amplifier utilizing 12 tubes. Around this set-up has been built the following numerous features. Volume expansion and compression (the latter tending to reduce microphone feedback); electronic visual overload and output level indicators; non-resonant equalizer used as tone balancer for both low and high frequencies; master gain control; and a 4-channel input with electronic mixing of 3 microphones simultaneously with phonograph auxiliary input.

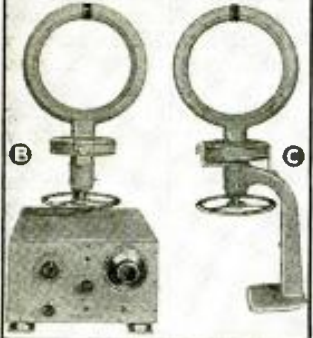

New direction finder for small boats. View A—set mounted in wheelhouse and loop-antenna mounted on deck above (may also be placed on chart-table of smaller boats); B—front-view of the equipment; C—side-view of the directional loop antenna. (1449)



An 80-W., portable amplifier that combines numerous features. (1450)

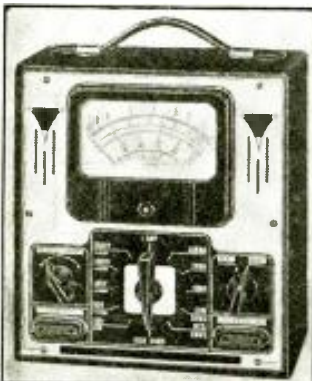

A wide-range of test values features this multi-purpose instrument. (1451)

NEW WIDE-RANGE MILLIAMMETER (1451)

(Precision Apparatus Corp.)

AN ANALYSIS of the ranges of this instrument immediately reveals its exceptional utility. Ratings, A.C. volts: 0/10/50/250/1,000/2,500 V. at 1,000 ohms/volt; D.C. volts: 0/10/50/250/1,000/2,500 at 1,000 ohms/volt; D.C.: 0 10 50/250/1,000 ma.; Resistance: low ohms (shunt method), 0-400 ohms, 20 ohms center (Resistance as low as 1/4-ohm can be comfortably read.); medium ohms, 0-1 meg.; high ohms, 0-10 megs. Note: Low and Medium Ohms are powered by a 4 1/2-V. battery; High Ohms powered by a 45-V. battery—all batteries self-contained; Decibels: -10 to +15, +1 to -29, +18 to +43, +30 to +65, -38 to +63; Output: 0/10/50/250/1,000 V. Additional features: multipliers—metallized, 1 per cent tolerance; shunt—individually wire-wound on bobbins to 1 per cent accuracy. Meter has large window opening, and large numerals etched on metal.

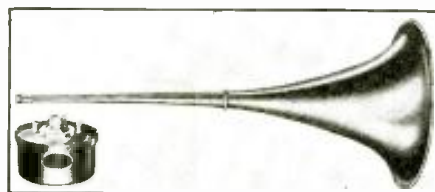

A new line of exponential aluminum trumpets and permanent-magnet trumpet units has been introduced. (1452)

Wiring—cabled; switches—ball-bearing types with silver contacts; panel crystal gold and black finish, etched on heavy brass; case—leatherette covered. Portable type measures 9 x 10 x 4 ins. deep.

NEW LINE OF P.M. TRUMPET UNITS AND ALUMINUM TRUMPETS (1452)

A NEW line of all-aluminum trumpets includes overall lengths of 41, 51, 63 and 72 ins., with bell diameters to conform to the various lengths. All trumpets are truly exponential from end of throat to tip of bell; all have extra-long, extra-heavy cast aluminum throats. The 41, 51 and 63-in. sizes are made in only 2 sections, the long, heavy cast throat and 1 heavy gauge aluminum spinning. The longer, heavier, cast-aluminum throat used with a single-section bell eliminates metallic throat resonance, and does away with vibration at welded or bolted joints where the trumpet bell is made in 2- and 3-spun sections.

The new permanent-magnet type of trumpet unit, shown in insert, is equipped with a diaphragm and voice coil assembly which, it is stated, makes possible greater efficiency without the danger of failure where continuous, heavy power input loads are employed.

The diaphragm is of the deep dish type which allows for winding of the voice coil directly to the diaphragm, permitting rapid dissipation of heat generated by the voice coil. It is the only diaphragm of this type which can be formed without annealing the metal before each drawing operation. This is said to be an important development as elimination of the annealing process makes it possible to retain all the original flexibility and "life" of the metal in the finished and drawn diaphragm.

The manufacturer of this new unit claims overall efficiency and input watts capacity equal to that of any electro-dynamic unit of same classification.

SET CONVERTER FOR AIR-CELL OPERATION (1453)

(National Carbon Co.)

AN INEXPENSIVE gadget is now available for adapting to operation from a 2.5 V. aircell, battery-type radio receivers originally designed for operation from 2-V. storage-cell units. This device, an insulated flexible resistor with ter-

(Continued on page 180)

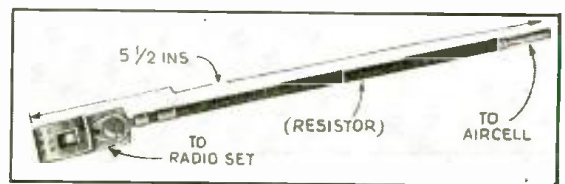

This resistor permits 2V. (storage cell type) radio sets to be operated from the higher-voltage aircell. (1453)

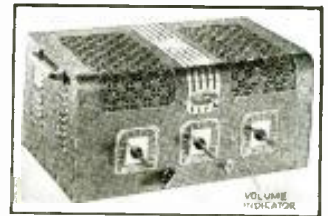

Newest P.A. amplifier. (1454)



Electronic frequency modulator. (1455)

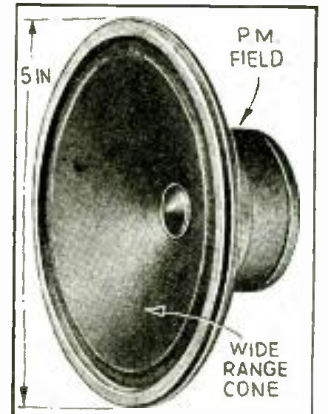

One of a new speaker series. (1456)



General service amplifier. (1457)

Name and address of any manufacturer will be sent on receipt of self-addressed, stamped envelope. Kindly give (number) in above description of device.

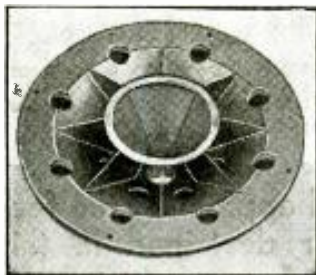

Sound diffusing speaker. (1458)

NEW LOUDSPEAKER FEATURES BUILT-IN SOUND DIFFUSER (1458)

HERETOFORE only expensive radio sets have featured the use of *diffusing vanes* as an integral part of the cabinet to obtain uniform distribution of the high frequencies throughout the room.

The new loudspeaker here illustrated incorporates the sound diffuser integral with the loudspeaker to obtain uniform sound diffusion through an arc of about 180 deg. when used in a conventional radio cabinet. When suspended horizontally and the sound projected down, in P.A. installations, diffusion of 360 deg. is obtained.

This design is said to prevent amplitude and harmonic distortion by introducing loading on the moving cone; and it is claimed that no loss of volume is encountered. Manufactured in 10- and 12-in. sizes.



Low-power P.A. system. (1459)

PORTABLE 5-W. P.A. SYSTEM (1459)

(The Radolek Co.)

THIS system is especially well adapted for window demonstrations, auction sales, lectures, and all other applications requiring inexpensive sound equipment of low power.

A type 6F5G tube in a high-gain circuit drives a type 6B5 dual-triode tube that delivers an output of 5 W.; the rectifier is a type 83 tube. The frequency characteristic curve is flat within 2 db. from 40 to 9,000 cycles. Field current is provided for the 11-in., 2,500 ohm dynamic speaker. The complete system includes the amplifier, tubes, speaker, a high-quality double-button microphone mounted on a banquet stand, and all necessary cables and plugs. The system is housed in a sturdy carrying case that provides easy portability and serves as the baffle for the speaker.



Auto-radio tuning wrenches. (1460)

AUTO-RADIO TUNING WRENCHES (1460)

ILLUSTRATED here is a set of 10 auto-radio tuning wrenches for the Service Man. They come complete in a leatherette roll. Used for aligning and tuning the car-radio set either in the car or on the bench. Each tool has flexible shaft and adjustable bushing.

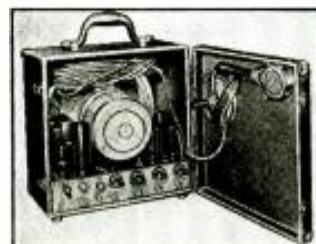

Sound reinforcing amplifier. (1461)

SOUND REINFORCING AMPLIFIER (1461)

(Sundt Engineering Co.)

IN A CARRYING case measuring 3 1/2 x 13 1/2 x 9 ins. deep is a power amplifier with an output of 12 W.



Accurate signal generator. (1462)

A 12-in., 15-W. dynamic loudspeaker, microphone extension cable, a hand microphone, and a banquet stand for table use. May operate from 110 V. A.C. or by means of a converter from a battery. Designed for use by public speakers, orchestras, showmen, etc., and in fact wherever a small, easily set up speaker system is desired.

NEW R.F. SIGNAL GENERATORS FOR HIGH ACCURACY (1462)

(Clough-Bregle Co.)

THE TYPE OC-A R.F. signal generator here shown is one of 3 instruments all having the same general specifications: the model OC-A for A.C. supply, the OC-B. for A.C.-D.C. operation, and the OD-A for use with self-contained batteries.

Each band is hand-calibrated to a guaranteed frequency accuracy of 1/2 per cent. Dial length of 25 ins. per band. New dual, stepless attenuators for both R.F. and A.F. output voltages. Plug-in sealed output lead. Switch selection of unmodulated R.F., modulated R.F., and pure sine wave 400-cycle A.F.—all available at the same output jack.

The jet black crystalac case contrasts with a broad, etched, panel plate finished in emerald-green with silver trim. The frequency range is 90 kc. to 30 mc.

AUTOMATIC RESET THERMO-OVERLOAD SWITCH (1463)

(General Electric Co.)

A COMPLETELY self-contained thermo overload switch for fractional horsepower motors, operating on line current and arranged for convenient mounting on the terminal box of the motor, has recently been placed on the market under the trade name Thermo-Tector.

As the interior illustration shows, the switch elements consist of (1) a thermo-static bi-metallic helix, (2) a heater helix, (3) a steel spring, (4) a contact arm, and (5) a slotted arm. Completely surrounding the bi-metallic helix is a low-resistance heater connected in series with the motor winding.

When the bi-metallic helix is heated to a temperature above normal it is free and rotates, and thus reverses the normal bow of the spring; and in passing dead-center the spring also moves a contact arm and disconnects the motor from the line. With the line open, current ceases to flow in the heater helix, the bi-metallic helix turns in the opposite direction, and when the temperature is again normal the spring snaps to the "on" position.

(Continued on page 183)

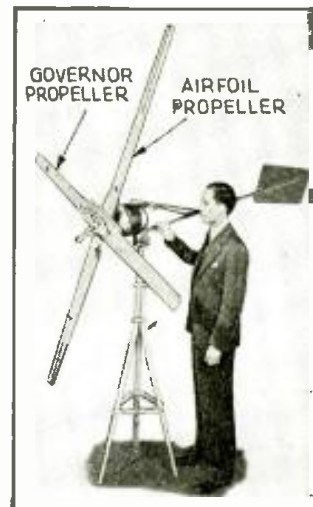

Latest wind-charger has a second or governor propeller at right-angles to the main one. (1466)

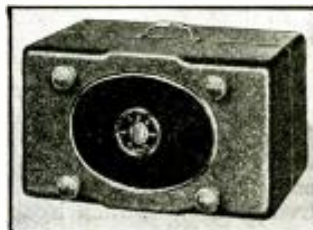

New trailer or home-radio receiver has car-radio sensitivity. (1467)

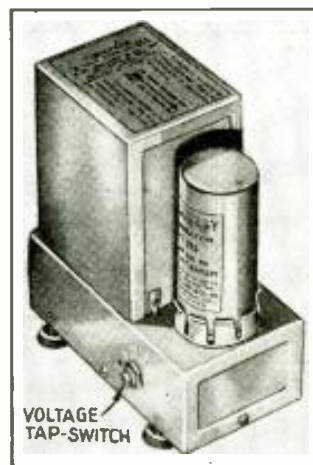

Portable power unit for pin games; P.A. amplifiers, etc. (1468)

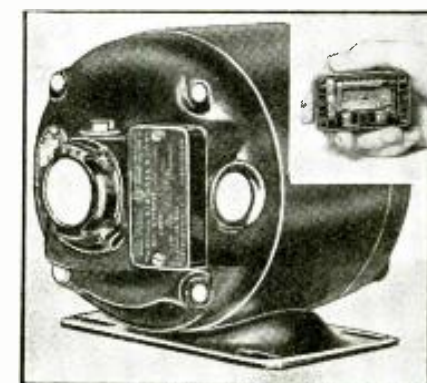

Thermo overload switch; insert, interior view. (1463)

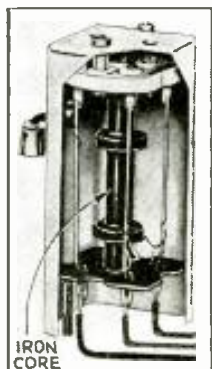

One of a new line of iron-core transformers. (1464)



New multi-feature dynamic microphone. (1465)

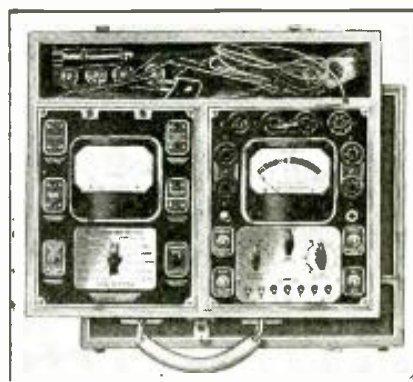

A complete servicing set in one portable case. (1469)

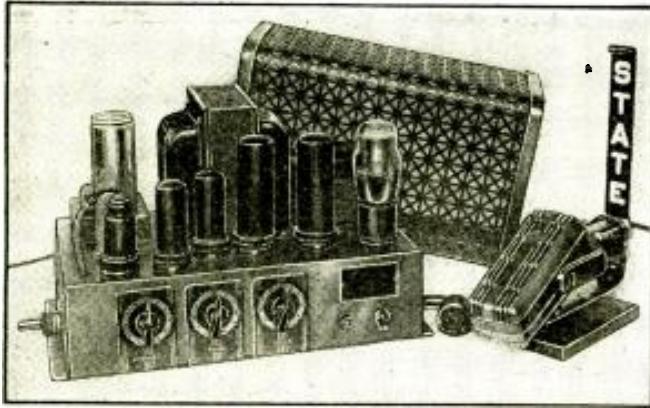

Fig. A. Amplifier with adjustable frequency response.

COMPENSATION OF AMPLIFIER RESPONSE FOR LOCAL NEEDS

Public-address men will appreciate the features of the amplifier described in this article. Nine different frequency-response curves may be obtained merely by manipulating response controls.

S. RUTTENBERG

IT IS ALMOST impossible to satisfy everybody with one particular amplifying system. Some prefer low-pitched reproduction — others, high. Then again the speakers as well as the acoustics of various rooms are so different that some compensation device must be used to obtain best results.

In any P.A. installation, it is of paramount importance that the reproduction be free from peaks. It is the peaks that tire the listener. A slightly rising characteristic is not at all objectionable. The best method to obtain this result is to start off with a flat microphone and flat amplifier and introduce compensation in the amplifier, as required.

In order to create the illusion of hearing the original, not only must the fre-

quency response be wide enough but the sound must have its original loudness. In movie and large hall installations, a signal louder than the original is required, in small rooms a signal lower in volume than the original. With a lower signal, it is usually more desirable to increase the low-frequency response in order to create the illusion of the original, while with the louder signal it is best to increase the higher frequencies.

A system which can introduce a slightly rising characteristic is therefore immediately adaptable to practically any sound installation, and can please any taste.

Equalizing devices have been used for a number of years to compensate for the losses in telephone lines. How-

ever, that type of equalizing system is not practical, due to its large cost and decrease in overall efficiency. Besides those compensating devices tend to introduce distortion of their own, due to

(Continued on page 170)

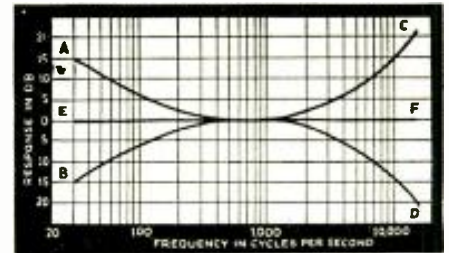

Fig. 2. The 9 frequency-response curves (AC, AF, AD, EC, EF, ED, BC, BF, BD) from this amplifier.

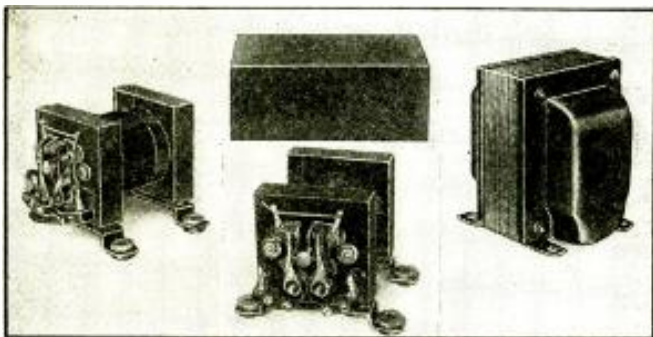

Fig. A. The storage-battery power unit and its double sound-proof case.

Hi-VOLTAGE POWER FROM A STORAGE BATTERY

A means is described, for obtaining high voltages from a low-voltage source, that overcomes the difficulties usually encountered in other systems, at high current drains.

LOUIS GANCHER

THE PRODUCTION of D.C. voltages of 250, 300, 350, 400, etc., from a storage battery, for the operation of sound truck amplifiers, ordinarily is accomplished by *dynamotors*. Such devices, while performing admirably, are limited in scope since their output (referring to the most popular types, those averaging \$40.00 list price) does not exceed 36 W., as follows: 250 V. D.C., 0.145-A. (volts times amperes equals watts); 300 V. D.C., 0.12-A.; 350 V. D.C., 0.103-A.; 400 V. D.C., 0.09-A., etc.

If the power supply requirements exceed 36 W., then 2 dynamotors would of necessity have to be employed along with their attendant increased bulk and weight, double cost and double battery drain.

With the battery-operated power supply here described, however, up to 65 W. may be produced employing an auto-

mobile 6 V. storage battery. If a 12 V. storage battery is utilized, then up to 120 to 130 W. may be produced. It consumes 12.4 A. when the full 65 W. is utilized, whereas the 36 W. output dynamotor referred to consumes 10 A. at full load output. It can be readily seen that the new device, which has been termed the Stor-Bat, provides considerably greater power output in proportion to the input current drain of a dynamotor.

ELEMENTS OF THE NEW POWER UNIT

The *stor-bat* consists essentially of a compact, noiseless and highly efficient motor, upon the shaft of which is firmly fastened an eccentric cylindrical metal cam. This cam "makes" and "breaks" the 4 contact arms with tungsten "points" welded on. As the motor shaft revolves 2,500 r.p.m., approximately 42

circuit interruptions of each set of contacts are produced per second.

Similar to automobile-radio receiver vibrators, the outside tungsten points are connected to the ends of a 12 V. center-tapped primary of a 40-cycle

(Continued on page 177)

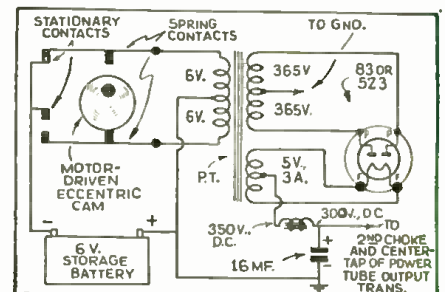

Fig. 2. Diagram showing both primary and secondary circuits of the new storage-battery power unit.

A 120-WATT "CATHODE-DRIVE" HI-FI AMPLIFIER

Read how "cathode-drive", in a new "bridge driver", together with "negative feedback", permit obtaining high fidelity at high power levels.

A. C. SHANEY



Before the advent of the 6L6 tube it was impossible to economically produce 120 watts of audio power within reasonable distortion limits, unless transmitting-type tubes were used, which of course necessitated excessively high voltages for the plate circuits.

Although the initial release of data covering the application of the 6L6 tubes rated two 6L6s as capable of delivering 60 watts of audio power when operating with a plate voltage of 400, screen-grid potential of 300 V., and with a control-grid fixed-bias of 25 V., few technicians were able to produce equipment that would realize this power output. The reason for the apparent discrepancy between the manufacturer's ratings and practical performance was soon found to be caused by an inability to build a

practical amplifier with (1) a *zero-impedance driver*, and (2) *perfect plate and screen-grid voltage regulation*.

Conventional driver design necessitated the use of comparatively high plate load in the driver circuit. This prerequisite made it impossible to design a transformer with zero or near-zero grid-circuit impedance.

A NEW BRIDGE DRIVER

It was therefore necessary in the design of this high-fidelity high-power amplifier to first attack the driver problem. The necessity of maintaining a low input-grid impedance to the power output stages suggested the idea of splitting the plate load of the push-pull drivers into sections, one-half of which was inserted into the cathode circuit and the other half into the plate circuit. The finished design utilized 2 special transformers as illustrated in Fig.

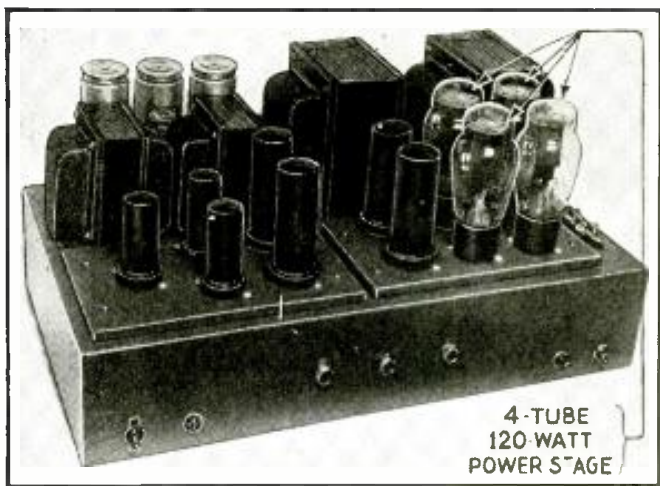

Fig. A. Appearance of the 120-W. "cathode-drive" beam-power amplifier.

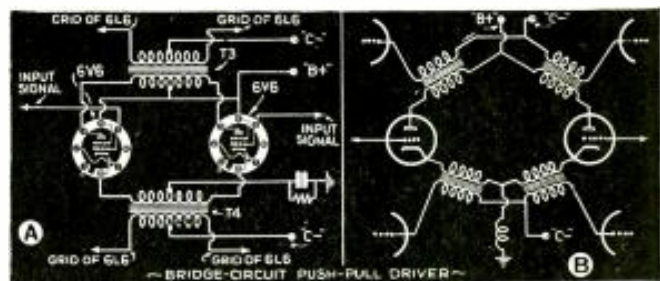

Fig. 2. Schematic of the bridge-circuit, push-pull driver stage; B, break-down diagram of the driver stage showing relationship to a bridge circuit.

2, A and B. These bridge driver transformers enable 4 6L6s to be driven to their full power output without introducing excessive grid-circuit impedance. By splitting the effective plate load of the drivers, the *reflected impedance* required in the plate circuit is automatically halved. By inserting one of the transformers into the cathode circuit, the high primary impedance requirements are no longer necessary and it is possible to design an efficient driver transformer with a negligible grid-circuit impedance. This feature of course, helps towards the attainment of the ideal 60-W. output at 2 per cent harmonic content from each pair of 6L6s. A peak output of 168 W. is possible from all 4 output tubes. Of course, there are other design factors which enter into the unusual performance of this amplifier.

THE INVERSE FEEDBACK DRIVER

By utilizing the cathode-drive principle in the first stage, inverse feedback is introduced, thereby correcting inherent plate- and grid-circuit distortion. The operation of this stage is as follows:

Self-bias is maintained by the insertion of the primary of the input push-pull transformer as well as an auxiliary, bypass resistor into the cathode circuit. The voltage drop developed across the effective resistance of the transformer primary and resistor is, of course, applied as a grid bias to the first 6V6 tube. As the control-grid approaches zero potential, more plate current flows, thereby producing a greater volt-

(Continued on page 176)

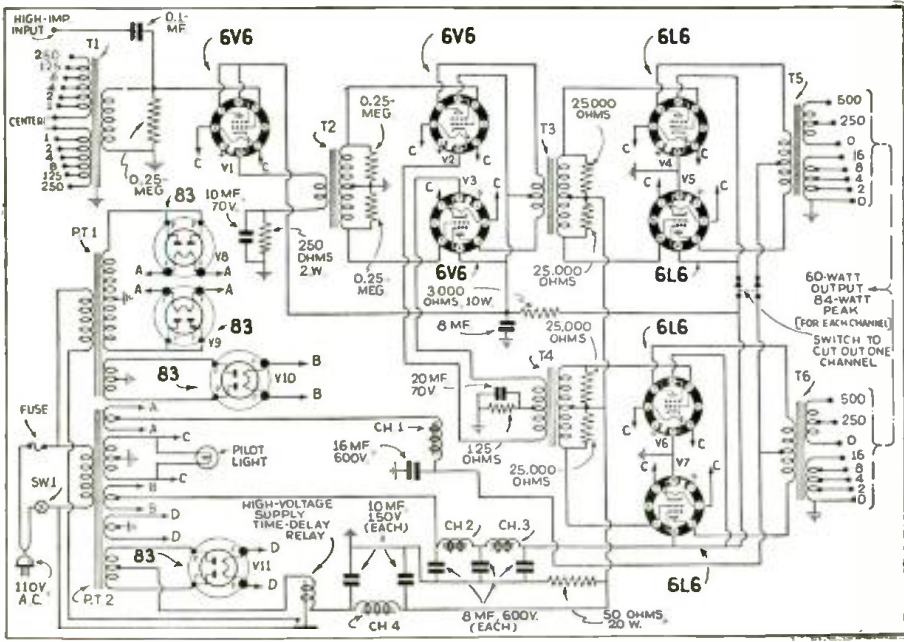

Fig. 1. Schematic circuit of the complete 120-W. beam-power amplifier.

NEW RADIO SETS

Radio sets for the forthcoming season exhibit many unusual features as compared to sets of previous seasons. However, only a few of the more outstanding designs are described in this review. In some instances the circuits, in addition to the housings, are of interest.



Fig. A. The Wilcox-Gay "Wall-Radio" set requires no floor or table space.



Fig. B. Rear view of the "Wall-Radio" set.

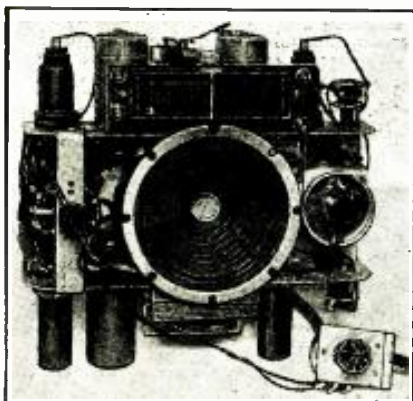

Fig. C. The compact chassis of the "Wall-Radio."



Fig. D. The International Kadette Model 449 "Equafonic" receiver.

WILCOX-GAY WALL RADIO SET

DESIGNED expressly to hang on the wall, this radio set requires neither floor nor table space. It is as easy to put in place as an electric clock.

Its streamlined metal case is but 3 ins. thick x 10¼ ins. square, yet, by virtue of its unique construction, contains a complete A.C. superheterodyne receiver. Features include 5 all-metal tubes; automatic volume control; slide-rule type dial using a glass light-refracting scale; and, dynamic speaker. Sensitivity and selectivity are of a high order.

The set has a built-in aerial which is usually satisfactory for local reception. However, an outside aerial wire is molded in with the line cord so that only a single cord runs to the set, the same as to an electric clock or lamp.

The schematic diagram of this receiver is illustrated in Fig. 1. Figures A, B and C illustrate the comparative size and chassis view of this receiver. The metal case is finished with a beautiful iridescent enamel in contrasting tones of black and silver, although brown and gold, green and cream, and red and gray hues are also available.

(Readers will recall that September, 1936 *Radio-Craft* contained probably the first wall radio construction story. The more modern commercial design achieves unusual beauty and compactness.)

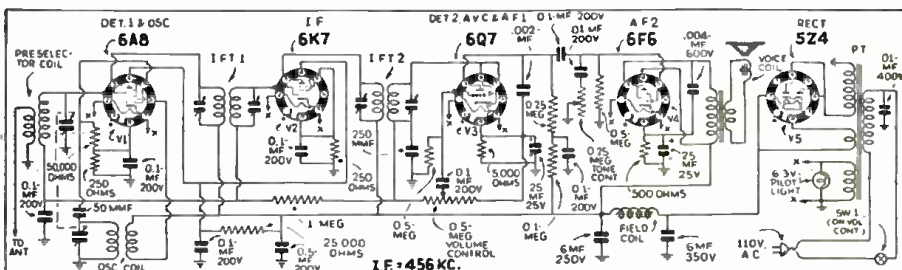

Fig. 1. Schematic diagram of the Wilcox-Gay "Wall-Radio" superhet. receiver.

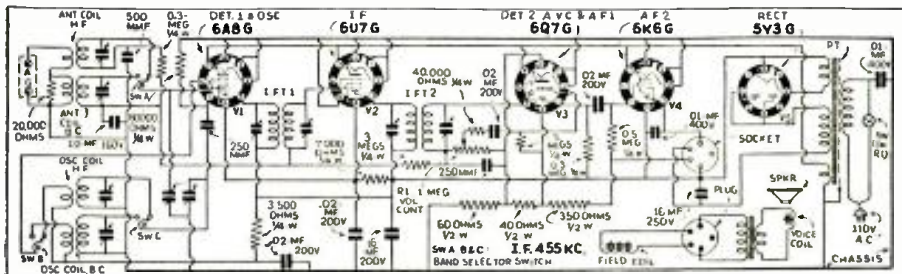

Fig. 2. Schematic diagram of the Crosley "Telefuno" Compact Five.

INTERNATIONAL KADETTE "EQUAFONIC" SET HAS NEW METHOD OF PROJECTING SOUND

IN THIS NEW model, which is of the arm-chair type, the speaker cone is mounted horizontally. Immediately above this cone is a special baffle designed to carefully computed acoustical curves which bend the sound waves and project them in all directions. The grilles are located on all 4 sides and equal volume intensity in all directions is obtained. An additional feature is the inclusion of a cocktail service.

The circuit diagram of this receiver is illustrated in Fig. 4. A 5-tube superheterodyne is employed, using a type 6V6 tube in the output stage. The set operates on 110 V., 60 cycles, A.C.

LAFAYETTE "TELE-DIAL" 17-BUTTON RECEIVER

THE NEW Lafayette Tele-Dial receiver, distributed by Wholesale Radio Service Co., Inc., tunes stations just like a dial telephone. Seventeen station control buttons are arranged around the periphery of an 8½-in. dial—more stations than the average person listens to from day to day. The set utilizes a 13-tube superheterodyne circuit, including type 6L6 beam power output tubes and a 6G5 visual tuning indicator. Two

FOR 1937-'38

An unusually large number of new features in radio sets for 1937-'38 are represented in the limited group of receivers described in this article. Among the more unusual features are the following: Special tone chamber for improved audio quality in mantle sets; button tuning combined with automatic frequency control; wall-mounting design, with integral power cord and antenna lead; end-table with improved sound-dispersion system.

12-in. auditorium dynamic speakers handle the large output.

Other features include 3-band continuous tuning from 16.4 to 568 meters, delayed A.V.C., automatic bass compensation, high-fidelity switch for increasing the band width of the I.F. circuits, tone control, and a power transformer which operates on 95 to 130 V., 50/60 cycles A.C., without adjustments.

The mechanical adjustment on the Tele-Dial receiver is carried to within 2½ kc. of a given station. A bi-metallic thermostatic condenser is said to be incorporated "to compensate for drift caused by temperate changes."

The other 3 buttons are for turning the set off, scanning the dial and to permit manual tuning. The mechanism is motor-driven to insure reliable operation. While the pointer moves across the dial the speaker is automatically silenced until the station selected is tuned-in. The automatic frequency control of the receiver then assures perfect tuning, even if the motor stops in only the approximate vicinity of the station desired.

Other attractive features are a tone monitor, which reproduces the highs and lows of sound in proper proportion; 2-stage intermediate frequency system, assuring maximum sensitivity; a large louvre dial, which permits easy visibility and the spreading of short-wave stations over a comparatively large surface; visual volume control indicator; a 4-band range; automatic band indicator; high-low speed tuning; automatic tone compensation; automatic volume control; preselector and wave-trap circuits; and a 12-in. stabilized dynamic speaker.

The set is designed to operate from a 115 V., 50/60 cycle, A.C. line, and consumes approximately 160 W. The cabinet is of modernistic design.

(Continued on page 187)

G.E. 13-TUBE "TOUCH TUNING" SUPERHETERODYNE

ILLUSTRATED in Fig. F is the G.E. model F-135 receiver housed in a large floor-type cabinet following the modern trend, particularly in the treatment of the grille bars and opening. Beneath the tuning dial of this set, there are 2 rows of buttons, 13 of which may be plainly marked with the letters of the more important stations in a particular locality. A mere touch of the button marked with the letters of the station desired and, automatically, the tuning indicator speeds across the dial to the one point where the program selected is tuned to hair-line precision.

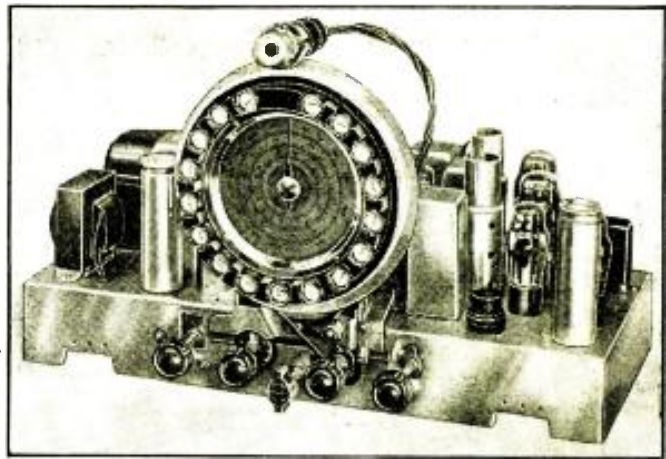

Fig. E. The Lafayette "Tele-Dial" 13-tube superheterodyne receiver.



Fig. F. G.E. model F-135 "Touch Tuning" receiver.



Fig. G. The Crosley "Teletune" Compact Five.

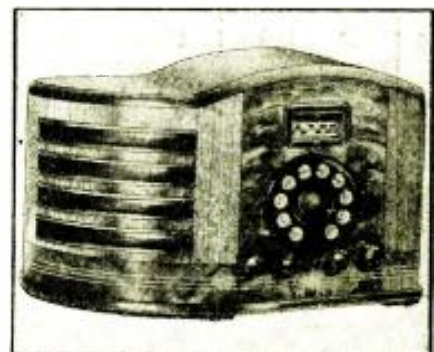

Fig. H. Emerson model AT-172 "Miracle Tone Chamber" set with automatic tuning.

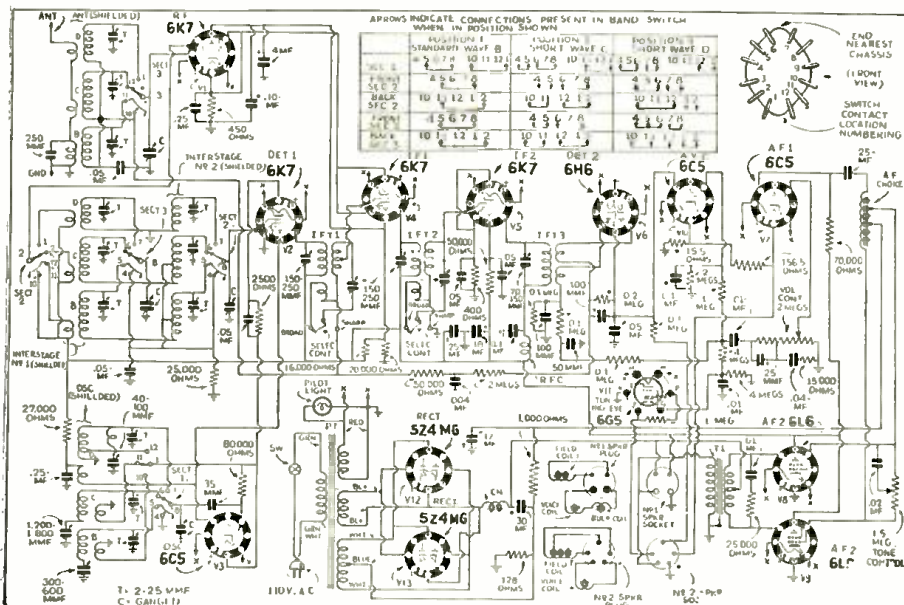
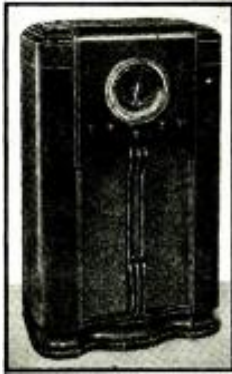

Fig. 3. Schematic diagram of the Lafayette "Tele-Dial" 13-tube superhet.

SENTINAL—ERLA MODELS 76-A AND 76AC

11 tube A.C. superhet.; automatic flash tuning, bass compensation, frequency control, interstation silencer; 3-bands; metal tubes.
(See Data Sheet 210 for schematic diagram)



Console model 76-A. The controls (left to right) are: A.F.C.; band switch; vernier tuning; vol. cont.; tone acoustic control. For fast tuning, a lever protruding from the lower end of the dial is manipulated.



Close-up of Flash-Tuning dial. (When a station tuning tab has been reached) close the flash-tuning circuit.

A few of the features of this Electrical Research Labs., Inc., radio set are high-lighted as follows:

A 4-point tone control provides: (1) two steps of bass boost with minimum high-frequency cut-out, (2) a normal treble or no bass boost, no high cut-out position, and (3) high cut-out position, similar to conventional tone controls.

Inter-station un-muting, when the A.F.C. position is in use, is controlled by contacts, on the dial lever arm provided for fast tuning, which restore the R.F. and I.F. grid bias to normal and at the same time (when a station

and turn volume control on full.

(d) Remove shields held in position by snap fasteners over A.F.C. test jack and over trimmer screw holes in the 1st and 2nd I.F. transformer shield cans.

(e) Peak 2nd I.F. transformer trimmers for maximum 465 kc. output by adjusting the 2 trimmers accessible through the 2 top holes in the 2nd I.F. transformer shield can. Do not touch discriminator (bottom) screw.

(f) Peak each of the 1st I.F. transformer trimmers for maximum 465 kc. signal output.

Aligning 1,720-540 kc. band. (a) Check tuning dial adjustment by turning gang condenser until plates touch maximum-capacity stop (completely in mesh), at which point the dial needle must be exactly even with the last line at the low frequency end of the dial calibration. If the dial needle does not point exactly to the last line, move needle to correct position.

(b) Remove test oscillator lead from grid of 6A8 tube and connect to receiver "A" antenna post through a 250 mmf. condenser.

(c) Adjust A.F.C. control to maximum left-hand A.F.C. "off" position and band selector switch for operation on the 1,720-540 kc. band.

(d) Set test oscillator frequency and receiver dial to exactly 1,720 kc., and bring in 1,720 kc. test oscillator signal to maximum output by adjusting 1,720 kc. oscillator trimmer G.

(e) Tune receiver dial and set test oscillator frequency to exactly 1,400 kc. Adjust 1,400 kc. R.F. (D) and antenna (A) trimmers for maximum sensitivity.

Aligning 1.68-5.6 mc. Band. (a) Replace 250-mmf. test oscillator antenna lead series condenser with a 400-ohm resistor.

(b) Adjust band selector switch to 1.68-5.6 mc., tune receiver dial and set test oscillator frequency to exactly 5.6 mc. Bring in 5.6 mc. test signal to maximum output by adjusting 5.6 mc. oscillator trimmer F.

(c) Tune receiver dial and set oscillator frequency to exactly 5 mc. and adjust 5 mc. antenna trimmer C for maximum sensitivity.

Aligning 5.55-18.5 mc. Band. (a) Leave 400-ohm resistor in series with test oscillator lead and place band selector switch for operation on 5.55-18.5 mc. band, tune receiver dial and set test oscillator frequency to exactly 18.5 mc.

(b) Adjust 18.5 mc. oscillator trimmer E to bring in 18.5 mc. test signal to maximum output.

been used. To do this leave test oscillator frequency at 18.5 mc., increase the output of the test oscillator and tune receiver dial to approximately 17.5 mc.; then rock the receiver dial slightly, and if the fundamental peak was used in aligning at 18.5 mc. the test oscillator signal will be heard at approximately 17.5 mc. on the receiver dial.

(c) Tune receiver dial and set test oscillator frequency to exactly 15 mc.

(d) Rock gang condenser slightly to right and left, and adjust 15 mc. antenna trimmer B for maximum 15 mc. test signal response.

(e) Set test oscillator frequency and receiver dial to approximately 600 kc. Then while rocking gang condenser slightly, adjust 600 kc. oscillator padder C4 for maximum signal response.

Aligning Discriminator Circuit. (a) After completing 1,720-540 kc. adjustment, set test oscillator to exactly 465 kc. and connect to control-grid of 6A8 tube through a 0.02-mf. condenser—insert lead of double-scale 0-1 and 0-5 ma. meter into A.F.C. test jack (located on top of chassis adjacent to the 6L6 tube). To avoid possibility of damaging the meter should one of its leads short to the metal chassis, always turn off receiver when inserting or removing milliammeter leads from A.F.C. test jack.

(b) Short out A.F.C. mute switch by grounding the second-from-the-left (looking at the front of the chassis) of the 4 lugs mounted on top of the dial assembly. The correct lug to ground is indicated in one of the illustrations.

(c) Turn receiver on, place A.F.C. switch knob in A.F.C. "on" position and if meter needle jumps off-scale adjust output of test oscillator until an approximate 2-ma. deflection is obtained on the 0-5 ma. scale.

(d) Place band selector switch for operation on 1,720-540 kc. broadcast band—and set receiver dial somewhere near 1,000 kc. at a point where no station is heard.

(e) Rotate A.F.C. switch knob from A.F.C. "on" to A.F.C. "off" position and note whether the meter reading changes as the position of the A.F.C. switch is changed. A noticeable change in reading indicates incorrect discriminator trimmer adjustment.

(f) Important: Do not adjust discriminator trimmer unless it is absolutely necessary. Place A.F.C. switch in A.F.C. "off" position and note meter reading, then place A.F.C. switch in A.F.C. "on" position and carefully adjust discriminator trimmer until meter reading is exactly the same as it was with the A.F.C. switch in the "off" position.

Note: If when adjusting the discriminator trimmer the meter reading does not sharply increase or decrease as the trimmer is adjusted even after several turns of the trimmer screw, this does not indicate correct balancing but does indicate incorrect adjustment and the discriminator trimmer should be set to about 1/2-capacity and the adjustment of the discriminator trimmer made all over again.

Note: When adjusting this trimmer 2 peaks, the fundamental and the image will be noticed. Care must be taken that the fundamental peak and not the image peak is used for aligning the receiver at 18.5 mc. Always back off trimmer E to minimum capacity, then screw down E (add capacity) until the first peak which is the fundamental and the correct one to use is tuned-in. If E is screwed down beyond the point where the first peak is received the incorrect image peak will be tuned-in. After completing adjustment of E at 18.5 mc., always check to see if the correct peak has

ALIGNING DATA

Alignment precaution—allow set to warm for 15 mins. before attempting alignment.

Aligning I.F. Stage at 465 kc. (a) Place automatic frequency control in the maximum left-hand A.F.C. "off" position.

(b) Attach the ground lead of the test oscillator to the chassis. Connect the other lead to the control-grid cap of the 6A8 tube through a .02-mf. series condenser. Do not remove grid clip.

(c) Set test oscillator to exactly 465 kc.

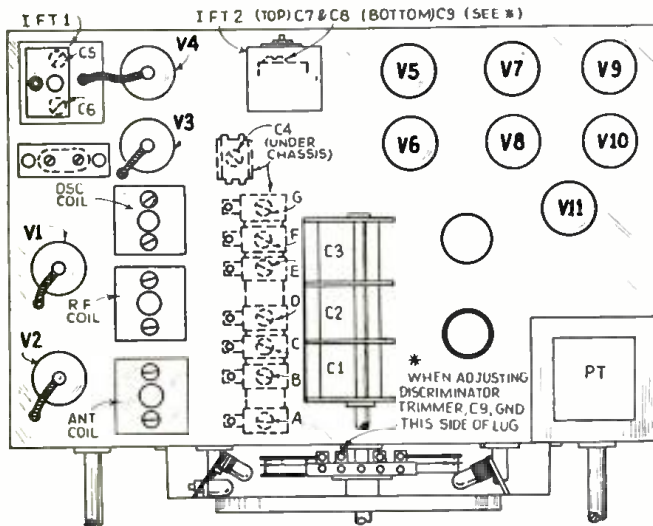

Chassis showing part and trimmer locations.

Radio Service Data Sheet

210

SENTINEL—ERLA MODELS 76-A AND 76AC

11 tube A.C. superhet.; automatic flash tuning, bass compensation, frequency control, interstation silencer; 3-bands; metal tubes.

(Continued from Data Sheet 209)

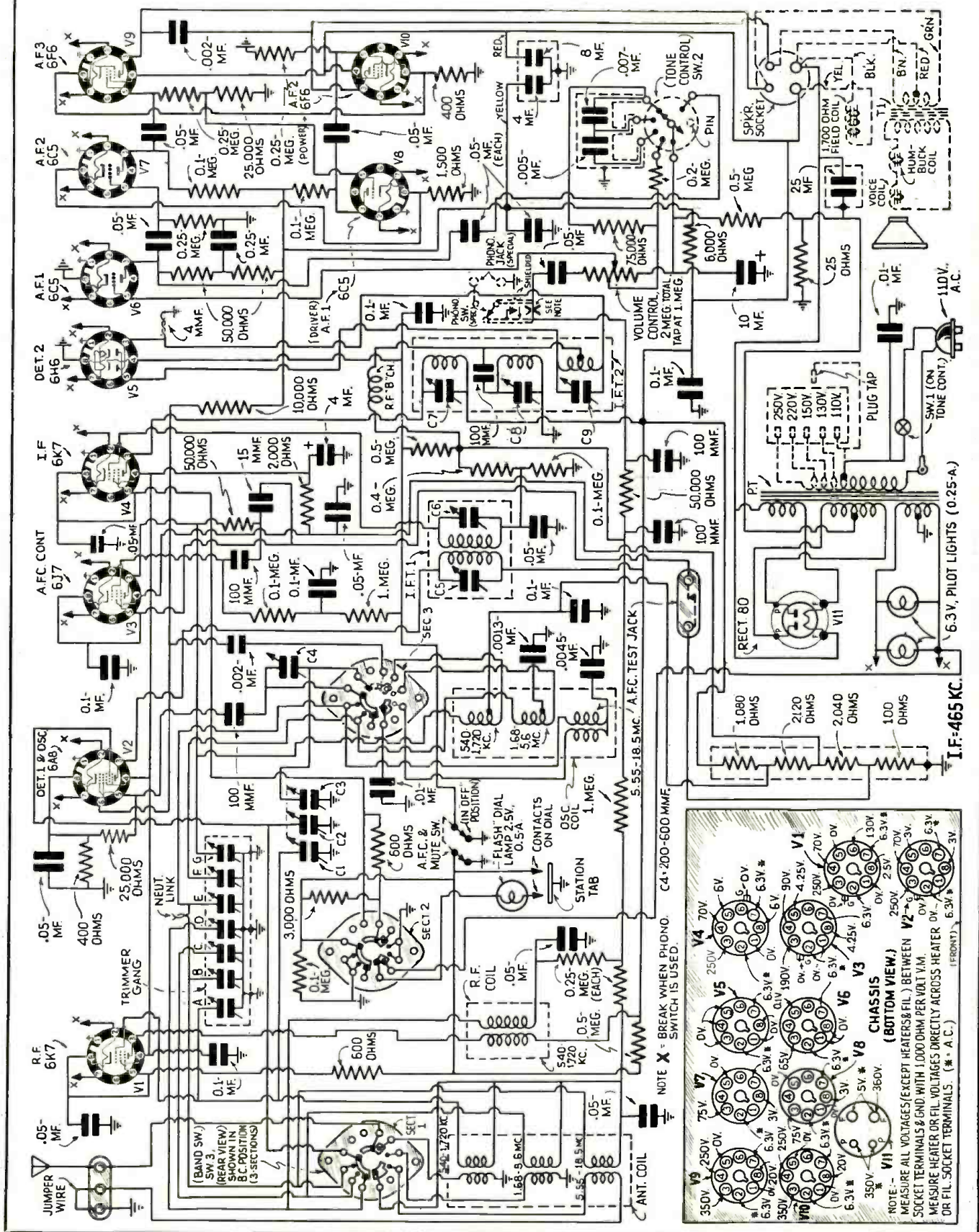

RADIO WITTIQUIZ

FREE—

—A 1-year subscription to RADIO-CRAFT to each person who submits a WITTIQUIZ that in the opinion of the Editors is suitable for publication in RADIO-CRAFT. Read the following WITTIQUIZZES; can you spot the correct answers? Now send in YOUR idea of one or more good WITTIQUIZZES based on some term used in radio, and win an award. (Contest rules appear on page 174.)

(1) It is generally known that *damped waves* are—

(a) Waves that have traveled through a rain squall. (b) Waves in close proximity to grid leaks. (c) Waves with progressively diminishing amplitude of successive cycles. (d) Waves with progressively diminishing latitudes of successive cycles.

(2) Anyone who dabbles in radio knows that a *grid leak* in a radio receiver circuit is—

(a) A definite cause of chassis rust. (b) A waste of energy. (c) An unnecessary nuisance due to negligence of the constructor. (d) A low-power resistor.

(3) A *watt* is—

(a) An expression of incomprehension. (b) The singular form of "wattles." (c) A unit of horse strength. (d) A unit of power equivalent to (1) 1/2,000th of a horsepower; (2) 1/746th of a horsepower; or, (3) 1/10⁻³ of a horsepower.

(4) A *velocity microphone* is—

(a) An instrument used by physicists for determining the speed of light. (b) A microphone which automatically increases the speed of sound waves. (c) A device consisting of thin metal ribbon between a permanent-magnet for transforming sound into electrical impulses. (d) A device consisting of a magnet between 2 ribbons for intercepting voice or music. (e) A microphone that can be easily speeded from one part of a studio to another in case of emergency.

(5) You have probably heard a radio *antenna* referred to as—

(a) A female relation. (b) Part of a bug. (c) A domicile for ants. (d) A suspended conductor for receiving radio signals. (e) An aerial wire for hanging wash. (f) A non-conducting aerial for radio transmission and reception.

(6) Radio men who have "been around" know that a *decibel* is—

(a) The 10th part of a bel. (b) Ten bels. (c) A dinner gong. (d) Ten o'clock. (e) An early Turkish coin about equivalent to our present U. S. dime.

(7) *Remote-control tuning* of course refers to—

(a) Tuning-in radio stations by mental telepathy. (b) Tuning the dial on a radio receiver. (c) Directing a second person to tune a radio receiver. (d) An orchestra leader. (e) Adjusting a distant resonating mechanism connected to a radio set.

(8) If you were sent to obtain a *variable condenser* you would expect to find—

(a) A component that performs erratically. (b) A device having adjustable electrostatic capacity. (c) A steam roller. (d) A fixed condenser with movable plates.

(9) If you are a short-wave enthusiast you will know that the *Heaviside layer*—

(a) Causes the "skip distance" effect. (b) Causes "skin effect" of high-frequency current. (c) Causes radio aeriads to sag in the summer. (d) Reflects radio waves back to their source.

See if your friends can guess the answers!
(Answers on page 174)



This trim, business-like service bench was designed and constructed by its owner, J. Lopez of Havana, Cuba. It's well laid out with plenty of shelves and drawers for replacement parts.

BRITISH COLUMBIA: SPRAY-SHIELD TUBES IN THE LIMELIGHT AGAIN

RADIO-CRAFT, OESMA, Dept.:

I am a reader of your very worthy magazine. I consider it a most valuable and educational monthly publication, and hope it will continue to grow in the future.

In reading over your June 1937 number, I see a letter from a reader in Australia. He speaks of the spray-shield tubes, with which I have had much practical experience. The tubes, he states, have contacts on the side at the base. Evidently, this tube varies structurally, some-

what from ours, which is manufactured by the Canadian Radio Corporation. The only contacts at the side of the base are clips for grounding the tube shielding. Although the construction of this tube has been improved considerably in the last year or two, I consider that they have been a complete pain in the neck, so to speak. They are notorious for being noisy. The current year's production of the octal-base spray-shield tube, I find extremely subject to burn-outs.

A discussion of these spray-shield tubes in your magazine, I'm sure, would be very much appreciated by many readers.

I'll be glad to exchange a few notes with our Australian Service Man, also with fellow readers in any and all countries.

W. G. FENN,
Mission City, British Columbia.

This comment, by our British Columbian correspondent, probably relates to entirely different tube types than those mentioned by our Australian commentator; several companies in various countries have brought out tubes having a metallic coating sprayed on. For instance, sets made by the Majestic company in the United States were built around the characteristics of glass tubes carrying a sprayed-on shield.

It is possible that the faults mentioned by Mr. Fenn may be attributed to manufacturing difficulties encountered in the transitional period during the change-over to octal-base design. There is no reason, so far as we know, why any radio
(Continued on page 174)

READERS' DEPARTMENT



Fig. A. The window display of Selfridge's—a London radio dealer. They're already selling television sets "over the counter"!

WILL ENGLISH TELEVISION INTRODUCE THE TELEVISION SERVICE MAN?

Middlesex, England:

An English correspondent writes to *Radio-Craft* as follows:

Possibly some of your American readers would be interested in the enclosed picture (Fig. A—Reproduced here—*Editor*) which shows home television sets being displayed and sold "over the counter" in England.

The television programs are getting across at present much better than most of us had hoped for, and I believe the B.B.C. engineers are

rather jubilant at having gotten something "ahead of America."

We realize what a marvelous device the "Emitron" camera is when we can recognize familiar buildings many miles away from the camera!

New ideas in studio technique are being tried and many queer effects can be obtained by mixing the output from two or more cameras, as might be expected. As many as 6 cameras at a time are used for various angles on a studio scene, and the master cameraman can choose the one which looks best on his monitor screens at any moment.

It is evident that, with the "radio pictures" coming into general use, there will be a need for a special kind of Service Man, to give instruction after sales. Imagine trying to explain to the dear old lady who bought a set last week why the picture keeps "sliding off the edge of the screen"! Such a condition occurs with misadjustment of the vertical sweep control. Wrong setting of the horizontal sweep is apt to make one see "two of everything."

Much attention will probably have to be devoted to the interference problem. Automobile ignition seems to be the worst offender, causing black or white streaks across the picture. The noise can be heard while a car is a considerable distance away, and the disturbance does not spoil the picture until relatively close to the receiving antenna. It helps a lot to have the dipole antenna well up in the air, and reflector systems will undoubtedly provide a further improvement. (As Mr. Shrage points out in this issue of *Radio-Craft*, the use of "microwaves," i.e., waves under 1 meter in length, results in static-free television.—*Editor*)

(Continued on page 174)

**RCA ALL
THE WAY**

RCA Radio News

RCA Manufacturing Company, Inc. • Camden, New Jersey
A Service of the Radio Corporation of America

**EVERYTHING IN
RADIO-MICROPHONE
TO LOUDSPEAKER**

To the consumer, RCA means high quality performance at low cost... To the radio man, RCA means easier selling, higher profits

TUNING 50 TIMES EASIER

New RCA Victor Overseas Dial Is Short Wave Sensation

Electric Tuning Also Scores. Push a Button—There's Your Station!

Remote Tuning Achieved by Fool-Proof Armchair Control Device

Short wave fans are buzzing about the new 1938 RCA Victor Overseas Dial, a radical departure which makes short wave tuning easier than domestic.

The individual band scales representing the popular international entertainment bands are each 9½ inches long. This compares with the ¼-inch segments on the usual short wave dials. By actual measurement the crowded short wave stations are spread fifty times wider.



Each wave band lights up only when in use. Foreign stations appear by name on the dial scales.

The Overseas Dial is the leader of four improved dials in the 1938 RCA Victors. All are larger, easier to read.

Another major RCA Victor improvement is Electric Tuning—the first that's truly automatic. Push a button—there's your station. It's as simple as that. Gets any eight stations, foreign or domestic.

Electric Tuning may be extended to your easy chair with Armchair Control which may also be placed anywhere, in any room, that is convenient.

A fourth big new RCA Victor feature is the Sonic-Arc Magic Voice, which applies the principle of a band shell to bring finer tone, free from boomy reverberation.

RCA Victor Dealers are now demonstrating the 39 new 1938 models, ranging in price from \$20 up. All models incorporate a generous number of RCA Victor's 55 great extra-value features.

RCA Victor Model 811K, featuring new Straight-Line Dial and Electric Tuning, 11 tubes, new Sonic-Arc Magic Voice, Magic Brain, Magic Eye, RCA Metal Tubes, covers standard broadcast band and 49, 31, 25, and 19, 16 and 13 meter bands of international entertainment. Armchair Tuning available at slight extra cost, \$150. (f.o.b.) Camden, N. J., subject to change without notice.



Fall Radiotron Check-Up Gets Under Way

Gives Old Sets New Life... RCA Offers Outstanding Selling Helps



Window Display scheduled for delivery in September. See your distributor about yours.

To alert service men and dealers, September means the RCA Radiotron Check-Up Plan. Experience proves this plan gives radio dealers and service men a fine opportunity to make money.

The RCA Radiotron Check-Up puts new life in radios that are wobbling on their last legs. It's good for them. Makes them perform like they did when new. And it's a service most radio owners are glad to pay for—because the job is so satisfactory and the cost is so small.

To dealers and service men the Check-Up means more service jobs—at a minimum of \$1.50 a job. It means not only a chance to sell tubes, but by providing entry into the various homes in the community, an opportunity for the sale of many other electrical products.

The RCA Radiotron Check-Up is easy to sell: first, because it's an excellent service; second, because RCA backs it up with selling helps and advertising that does a job.

The Saturday Evening Post and Collier's will carry timely ads on Check-Up every other week. Real selling commercials will be plugged on a full hour radio program every Sunday. Besides these, there are scores of store helps available to you, plus tested direct mail pieces, such as letters and postcards, the Listening Ear, auto door hangers, auto radio check-up letters—every one of which packs a real selling punch. See your distributor.

Get behind the RCA Radiotron Fall Check-Up campaign—and your cash register will bang out a merry tune. Full details from your jobber.

Ask your RCA Parts Distributor for new RCA Parts Catalog and data about Magic Wave Antenna System.

New Antenna Cuts Noise

RCA Magic Wave Antenna System Operates up to 16 Outlets on One Antenna



No improvement in radio reception is more universally desired than the elimination or the reduction of noise. RCA now offers a product that does the job! The new Magic Wave Antenna System provides noise reduction on both standard and international short wave bands from 530 to 23,000 kcs. This is due to use of a new magnetite core transformer and the transmission line.

Operates 16 Outlets at One Time

The Magic Wave Antenna will operate up to 16 outlets on one antenna. This is possible through the use of additional special distribution and set coupling transformers.

The length of the antenna proper may be varied between 20 and 120 feet, making for ease of installation—yet retaining excellent efficiency. The transmission line is also variable to any desired length, again with a minimum of losses. No doublets or critical lengths required. Adaptable to existing installations.

Can Be Used for Vertical Installations

By using several lengths of ordinary iron pipe and reduction couplings, a high efficiency vertical antenna may be used in conjunction with the RCA Magic Wave System. By using stock number 12429, Submarine Cable, the transmission line may be buried and all unsightly wiring eliminated. Such an installation can be conveniently located remote from interference.

The new RCA Magic Wave Antenna System consists of one antenna coupling transformer and one receiver coupling transformer. Each coupling unit has two transformers in which magnetite cores are used. One of the transformers responds with greater efficiency on the standard broadcast band. The other on the international short wave band.

The Magic Wave Antenna System, stock 9812, lists at \$6.95, assembled in one complete unit ready for installation.

Please Say That You Saw It in RADIO-CRAFT

DICTOGRAPH A.C.-D.C. "SILENT RADIO" MODEL 91134 SERIES

A 6-tube (including ballast) "Silent Radio" broadcast superhet.

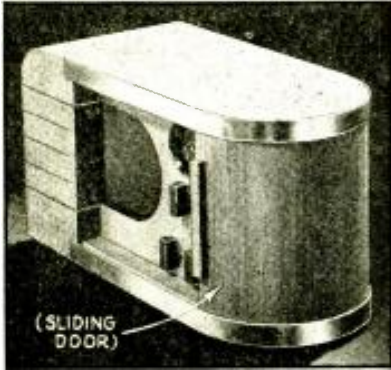

Appearance of the "Silent Radio" receiver.



The "mystic ear", tucked under a pillow, permits individual radio enjoyment without disturbing anyone close by.

This radio set affords optional loudspeaker (group) or "mystic ear" (individualized) program reception; the latter is desirable in hospital sick rooms, etc. Service data follow.

Connect the low-potential side of the signal generator to the metal chassis through a 0.1-mf. (400 V.) condenser for the following adjustments.

Adjustment of I.F. Condensers. (a) Remove the control-grid lead of the 6A7 tube and insert a 50,000-ohm (carbon type 1/3-W.) resistor in series with same. Then connect the high-potential lead of the signal generator through a 0.001-mf. condenser (paper tubular 400-V. type), directly to the control-grid of the 6A7 tube.

(b) Turn the rotor plates of the ganged variable condenser where no broadcast station carrier is heard (approximately 1,000 kc.). If this is not possible connect a 0.1-mf. condenser (paper tubular) from the oscillator stator section of the ganged variable condenser to chassis.

(c) Place an output meter (copper-oxide type) across the "mystic ear" terminals with the speaker control switch in a clockwise position so that variations in signal output can be noted.

(d) Place the signal generator in operation, adjust the carrier frequency to 456 kc. and regulate the attenuator control of the signal generator so that the output signal is low enough to insure accuracy in adjusting the I.F. condenser.

(e) Adjust trimmers T1, T2 and T3 (see sketch showing trimmer locations) to resonance as indicated by the greatest swing on the output meter.

Adjustment of Ganged Variable Condensers. (a) Remove the signal generator connection from the control-grid of the 6A7 tube and replace the control-grid lead. Then connect the antenna wire of the receiver to the high-potential lead of the signal generator through a 200-mmf. condenser (mica type).

(b) Set the dial pointer directly at the last long line at the right-hand side of the dial with the ganged variable condenser fully meshed. Then rotate the receiver dial to 1,500 kc.

(c) Adjust the carrier frequency of the signal generator to 1,500 kc. and, starting with trimmer T4 and then T5, adjust each for maximum signal output.

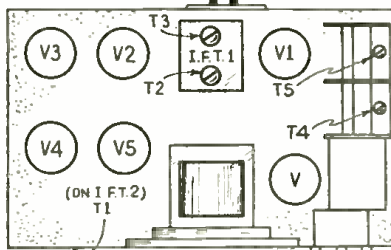

Chassis showing location of trimmers.

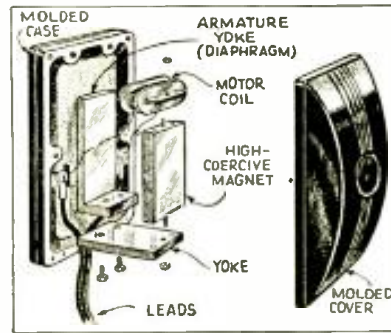

Exploded view of "mystic ear" construction.

Voltage Readings (at 119 V., A.C.):

Tube Type	Plate Volts	Plate Ma.	C.-G. Volts	S.-G. Volts
V1	108	1.4	2.6**	54
V2	108	2.2	—	—
V3	105	8.4	2.6	105
V4	36*	.05	6.2**	—
V5	90	20.0	15.0**	97
		78.0 TOTAL	—	—

*Taken with a 1,000 ohms/volt meter.
 **To be measured across bias resistor. Speaker field, 128 V.; filter choke, 15.5 V.

D.C. RESISTANCE VALUES, IN OHMS

Unit	Pri.	Sec.
Antenna coil	23.0	4.7
Oscillator coil	1.75	6.1
1st I.F. trans.	15.0	15.0
2nd I.F. trans.	25.0	25.0
Filter choke	400.0	—
Speaker input trans.	300.0	6.25
Speaker field	3,000.0	—
Speaker voice coil	3.0	—

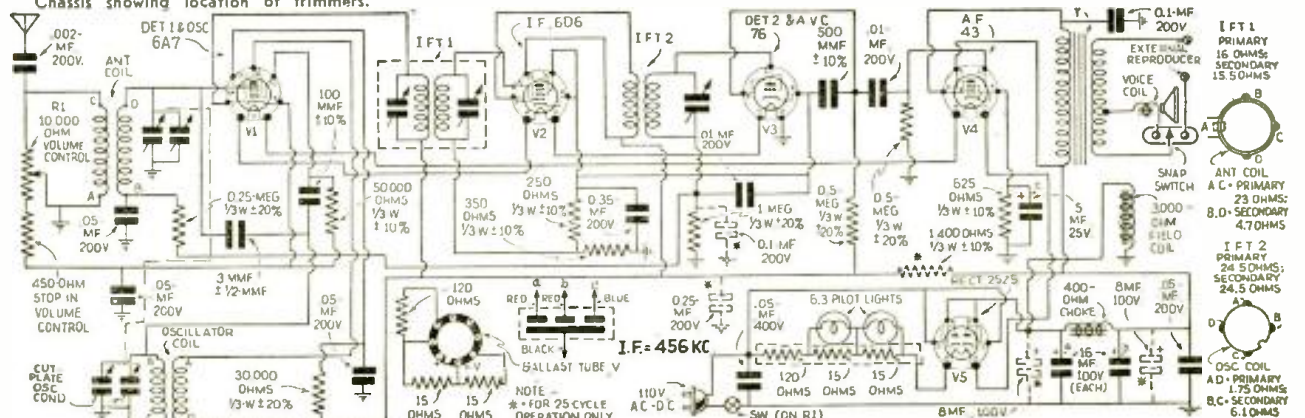

Schematic diagram of Dictograph Products Co. "Silent Radio" superheterodyne receiver.

HOW TO MAKE AN A.C.-D.C. INTERPHONE USING ONLY 1 TUBE!

(Continued from page 155)

7 stations, the number of points on Sw.3 must be increased proportionately, and the cable likewise. Also binding post strips will be necessary instead of the octal sockets used. (The constructor may wish to try the recently-announced type 25A7G, 25-V. tube—not as yet available to the writer—if increased amplification is desired.)

CHASSIS DETAILS, AND WIRING

In constructing the units, we first make the chassis as shown in Fig. 4. The main part of the chassis is formed from a piece of No. 16 gauge aluminum as shown in Fig. 4A. All holes are made with a No. 28 drill unless otherwise indicated. Next to, or in between the pairs of holes is indicated the part which is mounted there. Before the parts are mounted, flaps are bent down in order to form the chassis. The small front panel on which the switches are mounted is shown in Fig. 4B. This is fastened to the main chassis with two screws. The 3-in. P.M. dynamic speaker is mounted on the chassis by 2 small angle brackets.

In wiring the unit there are no special precautions except to note as already mentioned, that the "B"-minus return does not ground directly to the chassis.

The cabinet is shown in Fig. 5. The dimensions shown are for the inside of the box. The front panel should be 1/4-in. thick, and the sides may be any thickness desired.

The speaker hole may be the simple circular type shown; or else the grill type (Fig. A).

After the units are set up, try reversing the line plug while one station is transmitting to the other. The best position as to minimum hum should be noted and maintained. If the units have been wired up correctly there is almost no chance of trouble.

LIST OF PARTS

- One Sylvania type 12A7 tube, V (see text re 25A7G);
- One Sprague dual electrolytic condenser, 8 mf., 200 V., C1;
- One Sprague electrolytic condenser, 10 mf., 25 V., C2;
- One Cornell-Dubilier paper condenser, 0.1-mf., 200 V., C3;
- One Stancor input transformer, 4 ohms to grid, T1;
- One Stancor universal output transformer, type A-2855, T2;
- One 3-in. permanent-magnet speaker, P.M.;
- One "12A7" type socket;
- One 5-prong socket, S1;
- One Centralab D.P.D.T. switch, Sw.1;
- One Centralab S.P.S.T. switch, Sw.2;
- One I.R.C. resistor, 2,000 ohms, 1 W., R1;
- One I.R.C. resistor, 1,000 ohms, 1/2-W., R2;
- One resistor, 360 ohms, R3;
- One 5-prong plug, P1, P2;
- One chassis;
- One cabinet.

Additional Parts for Multi-Station Type

- One Centralab 7-point switch, Sw.3;
- One octal socket, S3;
- One octal plug, P-A to P-G;
- 8-wire rubber-covered cable.

*Names of manufacturers will be supplied upon receipt of a stamped and self-addressed envelope.

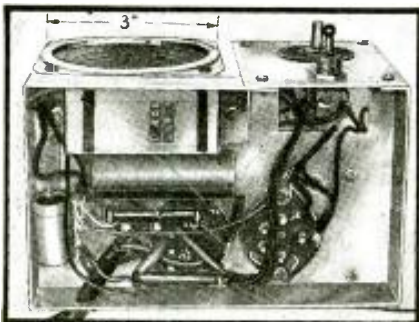

Fig. C. Under-chassis view of the communicator showing the simplicity of parts and wiring. The 3 in. speaker acts as both microphone and loud-speaker, being controlled by a switch.

N. U. ELECTRIC CLOCKS SELL SERVICE



FREE ON N.U. DEAL

This unusual example of beauty in a commercial clock was created by the largest advertising clock manufacturer in the world. It is a permanent high spot advertising fixture equipped for brilliant illumination as a night display with equal attractiveness in daytime use.

Get it FREE the NATIONAL UNION WAY

(Requirements less than 4 tubes per week)

National Union has given servicemen throughout the United States more than 70,000 pieces of fine equipment. If you're not taking advantage of National Union's service dealer plan, you're missing the greatest opportunity in the radio industry today.

ABOUT N. U. TUBES.....



National Union manufactures a complete line of radio tubes in glass, metal and G-type. National Union's high quality has made them the outstanding favorites in the radio service profession. All sales policies have been formulated with the idea of making National Union tubes the ideal replacement tube for the radio dealer. This has been backed up with a selling program that means real support and help to the wide-awake dealer. Dealers and jobbers handling National Union radio tubes are the leaders in repair parts and service. All you do is contract to purchase a few tubes per week, place a small deposit, which is refunded to you after the tube purchase is completed, and the equipment you have selected is yours "for keeps," without any strings attached. Meanwhile, remember that you have the use of the equipment all during the time tube purchases are being made.

↑
CLIP!
MAIL
NOW!
↓

NATIONAL UNION RADIO CORPORATION RC-937
570 Lexington Ave., New York City

—Tell me how to get free Electric Clock. Name

—I am interested in following Service Equipment Address

City State

NOW-GREATER SAVINGS THAN EVER

IN NEW RADIOS AND EQUIPMENT

FREE!

New LATEST CATALOG

CONTAINING HUNDREDS OF AMAZING RADIO VALUES

SETS AND ACCESSORIES

AT NEW LOW PRICES

We Carry Almost Every Radio Set Made TREMENDOUS DISCOUNTS

On Tubes, Amplifying Equipment, Public Address Systems, Auto, Home, and Farm Radios in all Styles, Types, and Voltages. We can supply you with any Manufactured Set.

ALL MERCHANDISE GUARANTEED

Factory Sealed Cartons. No Seconds

CHOICE EXCLUSIVE TERRITORY AVAILABLE TO LIVE REPRESENTATIVES

SKYCHIEF

A.C.-D.C. COMPACT R.C.A. LICENSED Built-in Aerial No Ground Necessary Illuminated Airplane Dial

\$5.19

Complete with Tubes

Post RADIO CORP. 72 CORTLANDT ST. DEPT. Q NEW YORK, N.Y.

Please Say That You Saw It in RADIO-CRAFT

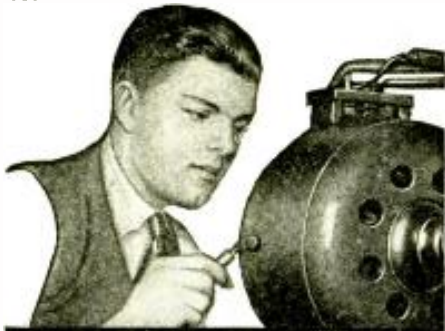

Amazingly Easy Way to Get into ELECTRICITY

Send Today for Details of "Pay-After-Graduation" Plan

Don't spend your life never sure of a job. Let us prepare you for your start in a good paying field. Let us teach you how to prepare for positions that lead to good salaries in Electricity—NOT by correspondence, but by an amazing way we teach right here in the great Coyne Shops. You get a practical training in 90 days. Mail the coupon below. If you are short of money I'll send you all details of my "pay-after-graduation plan" where many get my training first and start paying for it 5 months after they start school and then have 18 months to complete their payments.

LEARN BY DOING—IN 90 DAYS BY ACTUAL WORK IN THE GREAT COYNE SHOPS

I don't care if you don't know an armature from an air brake—I don't expect you to! Coyne training is practical "learn-by-doing" training. Don't let lack of money hold you back from getting all details of my amazing plan.

MANY EARN WHILE LEARNING

If you need part time work to help pay your expenses, we may be able to help you as we have hundreds of others. When you graduate we'll give you lifetime employment service. And, in 12 brief weeks, in the great shops of Coyne, we train you as you never dreamed you could be trained . . . on one of the greatest outlays of electrical apparatus ever assembled . . . real dynamos, engines, power plants, autos, switchboards, housewiring, armature winding and many other branches of Electricity.

Electric Refrigeration Air Conditioning

Right now we are including additional instruction in Electric Refrigeration and Air Conditioning without extra cost so that your training will be complete and you can get into this marvelous, rapidly expanding field.

GET THE FACTS Coyne is your great chance to get into Electricity. This school is 38 years old—Coyne training is tested. You can find out everything absolutely free. Simply mail the coupon and let us send you the big, free Coyne book with photographs . . . facts . . . opportunities. Tells you how many earn expenses while training and how we assist our graduates in the field. No obligation to you. So act at once. Just mail coupon.

BIG FREE BOOK
Send for my big book containing photographs and telling the complete story—absolutely FREE.
H. C. Lewis

COYNE ELECTRICAL SCHOOL

500 S. PAULINA ST., Dept. 67-78 CHICAGO, ILL.

H. C. Lewis, Pres., COYNE ELECTRICAL SCHOOL
500 S. Paulina Street, Dept. 67-78 Chicago, Ill.
Dear Mr. Lewis: Without obligation send me your big, free catalog with facts about Coyne Training and details of your "Pay-Tuition-After-Graduation" Plan.

Name Age

Address

City State

HOW TO MAKE "THE SEAFARER" LOOP-TYPE BOAT RADIO SET

(Continued from page 143)

to withstand full load and maintain tolerances over long periods of time.

(3) We selected bypass and other condensers which are exceptionally well impregnated and cased.

(4) We employed R.F. and I.F. coil components with windings thoroughly protected by wax dip. (Before building the receiver, we went over each and every terminal-to-winding connection, reimpregnating where necessary, and seeing to it that all strands of Litz were cleanly soldered-in.)

(5) We wired up the complete instrument with a special conductor designed for no-loss R.F. service (the nearest thing in dielectric efficiency we've been able to find to bare copper) and insulated with a washed and specially-treated textile which will not absorb moisture. This conductor maintains its dielectric resistance, and does not permit corrosive and electrolytic action due to water-salt-current effects.

(6) We reduced the number of wire-wound A.F. components to 2, one of which is the output transformer (a specially-protected item integral with the speaker); and the other an optional and perhaps unnecessary filter choke in the "B"-plus lead. Thus we have nothing at all to worry about in the way of possible primary winding breakdown—common to transformer-coupled receivers used in humid, salty atmospheres.

(7) We used a genemotor-type (combined motor and generator) power supply. We have every confidence in a well-made vibrator pack and do not wish to imply here anything to the contrary. But it just so happens that the dynamotor (as it is also called) as presently manufactured will stand up best in sea service—vibrators being, naturally, rather delicate components which might stick and require frequent attention in prolonged maritime operation.

(8) We engineered the complete set-up for proper operation with a special speaker. This speaker (which is not only proper for seafaring service but well adapted to general outdoor, vehicular, and seashore use) is an efficient permanent-magnet or "nokoil" job, complete with coil-impregnated and wax-dipped output transformer. Its cone has been carefully waterproofed on both front and rear sides, its cadmium-plated metal parts have been protected with lacquer clearcoats, and its voice coil is isolated with the usual "nokoil" solid-center cone spider—itsself waterproofed and protected.

We might note at this point, before we forget it, that the particular cabinet used for the laboratory model has no louvers for ventilation but simply a narrow slit in the back for access to battery input and speaker output binding post assemblies and phone plug, if one is desired. Further, use of a metal "front-of-panel" true micrometer dial has obviated any necessity for the usual large cutout. Thus the receiver becomes really well shielded.—A DISTINCTLY ESSENTIAL DIRECTION-FINDER FEATURE—so well shielded, in fact, that with the cover closed and no loop plugged in, and with gain and sensitivity controls advanced to full position, powerful local broadcasters will show not so much as an indicating hiss when we are tuned to their precise frequency! Figure 4 gives all its physical specifications for building the panel and chassis.

PARTS PLACEMENT AND LAYOUT

The 3-gang condenser is centered on the chassis pan. To the left of it are the R.F., I.F., A.F., and B.F.O. tube sockets—with I.F. and broadcast band coil components above the chassis and clearly distinguishable as to exact position (see Figs. 2 and 3). To the right is the power supply unit, with the on-off power switch on the front panel and, lined-up with the shaft (on the left) the loop-tuning trimmer condenser (which is also on the front panel). The 6E5 tuning "eye" direction and general signal indicator is mounted in its assembly, which is positioned at upper-left and secured to the output I.F. transformer shield can. Note that the broadcast band oscillator coil (in the round can) is behind the tuning variable and between it and the B.F.O. transformer.

The 2 shielded long-wave coils are mounted beneath the chassis (soldered, by the way, to the pan rather than bolted) and at one side of the wave-change switch. They are best placed in the exact position as shown and at right angles to each other.

Short-wave coils (in our case 2 for a single band) are mounted directly on the switch for rigidity and short leads. They may or may not require a shield partition between them.

On the lift cover is mounted the loop jack, to which is connected a short shielded lead for control-grid and ground tie to a 2-post assembly soldered to the variable condenser frame. The lead is made just long enough so that sufficient play will be had to permit reaching in and disconnecting control-grid and ground loop wires from the binding post assembly with the cover lifted about 6 ins. This feature enables us to conveniently break the tie when we wish to lift the cover completely or remove the front panel.

BUILDING THE RECEIVER

Layout specifications refer to the components mentioned in the List of Parts, and substitutions should be made with great care lest a completely different set-up be made imperative. It would be the wisest policy to use the designated items; they are all available through standard jobbing sources.

Wire up the set, first, for broadcast-band operation, connecting the coils in, of course, for switch selection. Shield the leads as shown in Fig. 1 (schematic diagram), particularly those running across the width of the chassis from volume and tone controls, those from the tuning "eye", and the grid lead for the loop jack. Ground these shields firmly to chassis. **SOLDER ALL CONNECTIONS CAREFULLY AND**

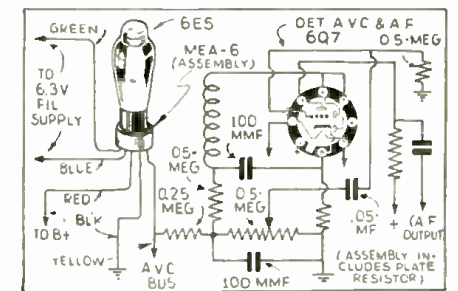

Fig. 5. Connections for the 6E5 "eye" tube, V7.

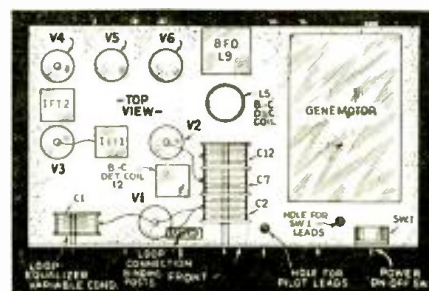

Fig. 2. Layout of parts on the chassis.

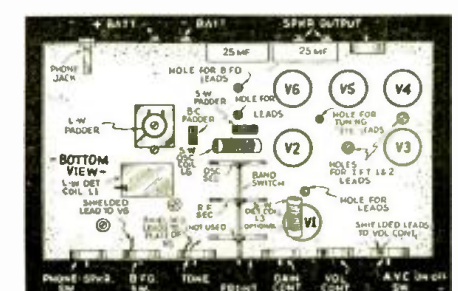

Fig. 3. Layout of parts under the chassis.

Please Say That You Saw It in RADIO-CRAFT

PERFECTLY. Connect one filament terminal at each socket to chassis. Use isolating resistors and bypass condensers in the plate and other circuits as shown in the schematic circuit, as the gain of this receiver is high and **STABILITY MUST BE MAINTAINED.**

Before adding the power unit, connect the tuner, if possible, to an exterior A.C. power pack capable of supplying well-filtered 250 V. at approximately 70 ma. Make sure that the power transformer filament winding (for 6.3 V. operation) is not center-tapped and then test the receiver for opens, shorts, proper voltages, alignment, etc.

Connect a short antenna through a small coupling device, such as a trimmer condenser or a few turns of insulated wire, to the 1st-detector signal-grid lead, and tune for broadcast signals. These should come in strongly (although not sharply, due to absence of preselection). Remove the antenna, close the cover, turn controls on for full R.F. gain and audio level. **NO SIGNALS SHOULD BE HEARD.** If they are intercepted, then the required perfect shielding is not being afforded by your cabinet.

The long-wave coils may now be added and connected in to the switch. Test for proper switching and general continuity, and add an antenna as for broadcast tests. You should hear ship and other code signals without difficulty—as well as airport weather phone if you are located reasonably close to a major field.

Procedure for the construction of the broadcast-band and long-wave-band plug-in loops as well as procedure for the operation of this set in the actual work of direction finding, will be fully described in Part II (of this series of articles) in a forthcoming issue of *Radio-Craft*. This will be accompanied with all necessary loop-calibration scales and direction-finding charts.

LIST OF PARTS

- One Meissner shielded broadcast R.F. coil, No. 2437, L2;
- One Meissner shielded broadcast oscillator coil, No. 4243, L5;
- One Meissner shielded long-wave coil, No. 7688, L1;
- One Meissner shielded long-wave oscillator coil, with padder, No. 7680, L4-C16;
- One Meissner padder for broadcast oscillator, No. D-2500, C15;
- One Meissner R.F. coil, police, RF3, or short-wave band, RF4, L3;
- One Meissner oscillator coil, police, 03, or short-wave, 04, L6;
- One Meissner special trimmer for police band, or Aerovox 0.002-mf. fixed mica condenser for short-wave-band padder, No. 1427, C14;
- One Meissner police-band antenna coil, A3, or short-wave coil, A4, if desired, L optional;
- One Meissner 3-rang variable condenser, types 15115 or 15117, C2, C7, C12;
- One Meissner waveband change switch, No. 16263;

- One Meissner input I.F. transformer, type 5740, 456 kc., L7;
- One Meissner output I.F. transformer, type 5742, L8;
- One Meissner B.F.O. transformer, type 6753, L9;
- One Meissner variable condenser, type 15106, or condenser, type 968, 150 mmf., C1;
- Five Aerovox condensers, type 484, 0.1-mf., C5, C10, C20, C27, C36;
- Seven Aerovox condensers, type 284, 0.1-mf., C3, C4, C8, C9, C18, C19, C28;
- Three Aerovox condensers, type 284, 0.05-mf., C6, C17, C21;
- One Aerovox condenser, type 484, 0.01-mf., C13;
- Three Aerovox condensers, type 484, 0.05-mf., C24, C26, C30;
- One Aerovox condenser, type 484, 0.006-mf., C31;
- Three Aerovox mica condensers, type 1468, 100 mmf., C11, C22, C23;
- One Aerovox condenser, type 1468, 250 mmf., C33;
- Two Aerovox electrolytic condensers, type PB25, 52 mf., C25, C29;
- One Aerovox dual electrolytic condenser, 8-8 mf., type PBS-5, optional, C34, C35;
- One Continental Carbon bakelite insulated resistor, type M-5, 1/2-W., 1 meg., R15;
- Two Continental Carbon bakelite insulated resistors, type M-5, 1/2-W., 0.5-meg., R19, R22;
- Three Continental Carbon bakelite insulated resistors, type M-5, 1/2-W., 0.25-meg., R5, R11, R20;
- Five Continental Carbon bakelite insulated resistors, type M-5, 1/2-W., 0.1-meg., R3, R7, R13, R21, R23;
- Three Continental Carbon bakelite insulated resistors, type M-5, 1/2-W., 0.05-meg., R9, R16, R27;
- Two Continental Carbon bakelite insulated resistors, type M-5, 1/2-W., 30,000 ohms, R10, R26;
- One Continental Carbon bakelite insulated resistor, type M-5, 1/2-W., 5,000 ohms, R18;
- Three Continental Carbon bakelite insulated resistors, type M-5, 1/2-W., 1,000 ohms, R4, R8, R14;
- Two Continental Carbon bakelite insulated resistors, type M-5, 1/2-W., 400 ohms, R6, R24;
- Two Continental Carbon bakelite insulated resistors, type M-5, 1/2-W., 300 ohms, R1, R12;
- One Electrad potentiometer, type 573, 12,000 ohms, R2;
- One Electrad potentiometer, type 203, 50,000 ohms, R17;
- One Electrad potentiometer, type 241, 30,000 ohms, R25;
- *One generator, type 2775;
- One Wright-DeCoster model 1196, speaker housing, with 980 Nokoil reproducer especially released for maritime service;
- One Kenyon filter choke, No. KC200, optional;
- Two rotary on-off switches, line type Sw.1, Sw.2;
- *Two midjet switches, type 10, Sw.3, and one (optional) for speaker-phones switch-over;

(Continued on page 172)

25,000 OHMS PER VOLT IN MODEL 1200 E Volt-Ohm- Milliammeter

- Resistance Readings to 40 Megohms.
- For all Radio Measurements Not Requiring a No Current Draw Vacuum Tube Voltmeter.

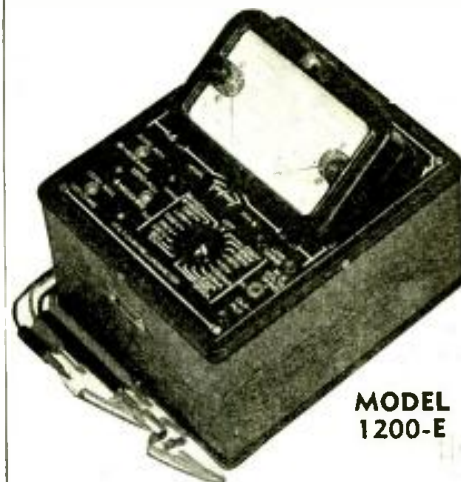

MODEL 1200-E

DEALER PRICE \$28.33

Readings:

- D.C. Volts 10-50-250-500-1000 at 25,000 Ohms per Volt.
- A.C. Volts 10-50-250-500-1000.
- 50 D.C. Microamperes, 1-10-50-250 Milli-amperes; 1 and 20 amperes.
- Resistance 0-500 Low Ohms; Backup circuit; 0-40,000 Ohms; 4 and 40 Megohms.

Triplet brings a new order of precision testing in this 25,000 Ohms per volt tester. Modern radio sets that require delicate balancing can be easily and quickly adjusted. Model 1200-E has separate A.C. and D.C. instruments in Twin Case with tilting feature for accurate reading.

A TRIPLET MASTER UNIT

Another of the series of popular co-related single unit testers, made in standard sizes, the most economical method yet devised for completely equipping the all-around radio service shop with high quality instruments.



TRIPLET ELECTRICAL INSTRUMENT CO.
169 HARMON AVE., Bluffton, Ohio

Without obligation please send me information on Model 1200-E Triplet Master Unit Volt-Ohm-Milliammeter. 1

I am also interested in

Name

Address

City State

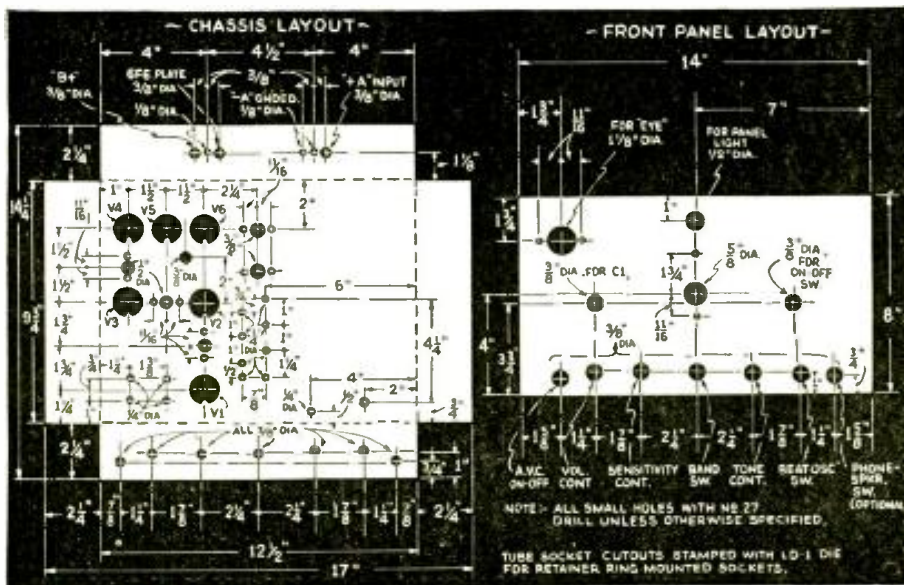

Fig. 4. Physical specifications for making the front panel and chassis for "The Seafarer."

Please Say That You Saw It in RADIO-CRAFT

COMPENSATION OF AMPLIFIER RESPONSE FOR LOCAL NEEDS

(Continued from page 158)

transients. The latter become very objectionable when the equalization amounts to more than 15 db. per octave.

In Fig. 2 is shown (detail spot) an inexpensive compensating circuit that permits gradual compensation of the low and high frequencies without any decrease in efficiency, or the introduction of annoying transients. This is used in conjunction with a degenerative amplifier—the latter permitting a large amount of power with a low percentage of harmonic distortion.

Standard parts are used throughout. All resistors without watts ratings are 1 W. Condensers below 1 mf. should be paper, except those marked mica. The push-pull input transformer is of the split-secondary type and is obtainable in standard makes. Positions M2 and M3 can be added if an

electronic mixer is needed—can be omitted if only one input is required.

Figure 1 shows the various curves obtainable with the above compensating device. Any of the 9 curves shown can be obtained by adjusting the controls. For example, a rising low- and high-frequency response can be obtained as shown in curve AC. Or if you prefer you can obtain the curves AF, AD, EC, EF, ED, BC, BF or BD.

A complete amplifier, with flat-response microphone, is shown in Fig. 2.

It is quite evident that even the most exacting person can be satisfied by a response following one of the above 9 curves.

This article has been prepared from data supplied by courtesy of Ampertite Corporation.

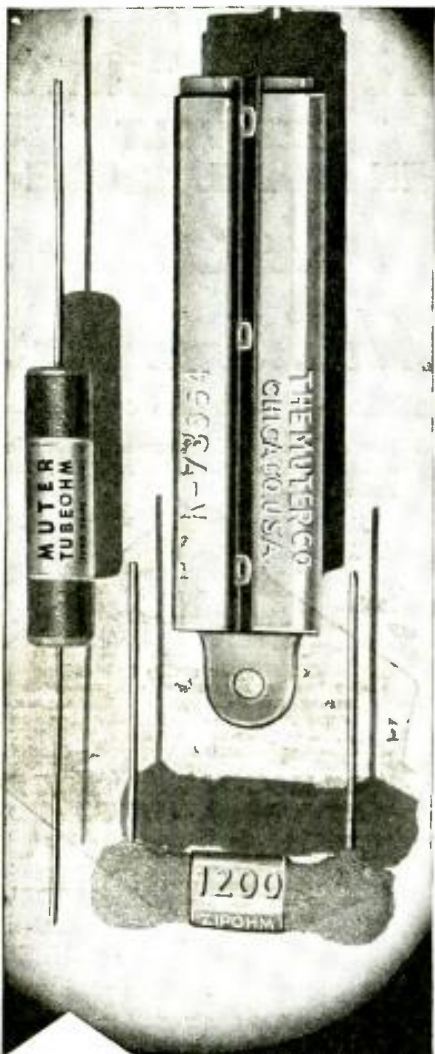

SPECIFY THESE LABELS

WHEN YOU BUY RESISTORS

ZIP OHMS—For quicker, better, more profitable wire-wound resistor replacements. Both 5 watt and 10 watt types. Clearly marked. Values up to 25,000 ohms. Shaped flat, for tight places. Long, adjustable, easily soldered leads. Noiseless. Permanently accurate within 5%. Perfectly moisture and heat-proof.

CARBON—The original equipment wire-wound resistor and voltage divider. Always replace with genuine MUTER duplicates. Give manufacturer's part number (stamped in the case) and name of set, or send actual unit to be replaced. An inexpensive replacement resistor with many applications.

THE MUTER COMPANY 1255 S. Michigan Ave., CHICAGO, ILL.

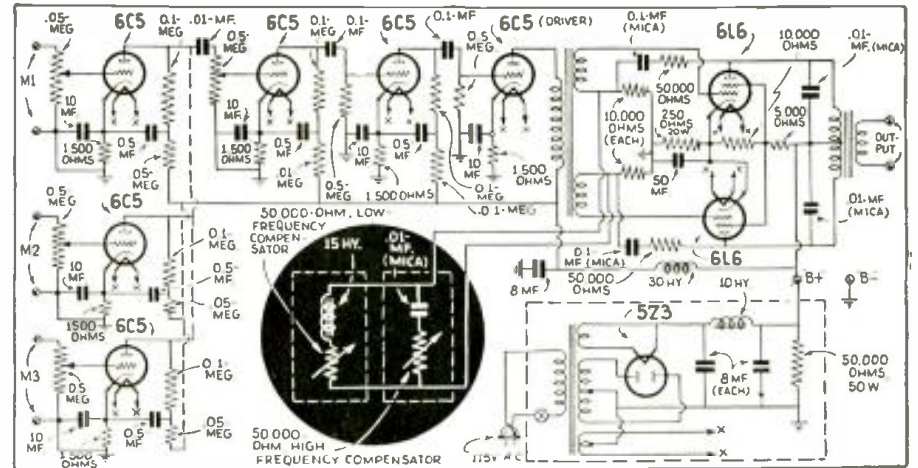

Fig. 2. Complete circuit of amplifier with facilities for varying its frequency response. The high- and low-frequency compensators are shown in the black spot.

THIS "POWER LEVEL" CHECKER MAKES DYNAMIC TUBE TESTS

(Continued from page 144)

duo-diode pentodes, and rectifier-amplifier tubes are checked for each function.

Short and Leakage Tests

Consider the tube under test as a resistance between plate and cathode. The plate meter is not connected for this test. If the tube is shorted, the neon bulb is placed across the high voltage through R1. The A.C. voltage causes the neon to glow on both sides. When there is an open, no voltage is across the neon, and no glow is obtained. Where a leakage path occurs, the neon glows on both sides but the glow is not so intense as at a short-circuit condition. Operation of the levers permits checking between all elements of a tube for these conditions. Plate-shorts are automatically indicated.

Diodes and Rectifiers

Diodes and rectifiers are tested under loaded conditions. Each section is separately tested very rapidly. Thus inconsistencies in these type tubes are quickly checked.

SPECIAL AND GENERAL FEATURES

The instrument has several features not ordinarily found in tube testers. An "H" switch permits rotation of the heater terminals to any

position on the octal sockets. Thus no adapters are needed to test tubes of the 5X4-5Y4-6P7 type. The "H" switch throws the heater voltage to the correct heater terminals, which are not the usual No. 2 and No. 7 prongs in the octal socket. Another interesting innovation is that line voltage is automatically recorded on the meter. No additional switch need be used for this purpose. (An external device, called the "gadget" permits checking of resistors and condensers. The resistance range is up to 1 meg.; capacity, up to 8 mf. at 300 V. A calibration is provided for this purpose.)

The test of a tube requires a 3-dial setup, and the motion of one or two levers. The indicating meter has a POOR-?-GOOD, and a 0-100 scale. The line voltage is controlled by a tapped primary switch. An index is furnished for all type tubes. These lists are mailed free on request. In conclusion, this test instrument (identified commercially as the Checkatube C 111) tests tubes on a dynamic power principle that takes account of all the electrical characteristics of the tube.

This article has been prepared from data supplied by courtesy of J-M-P Mfg. Co.

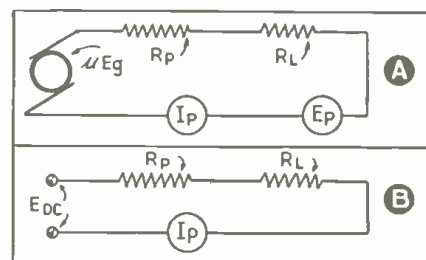

Fig. 2. Electrical circuit of tester with respect to the plate of the tube.

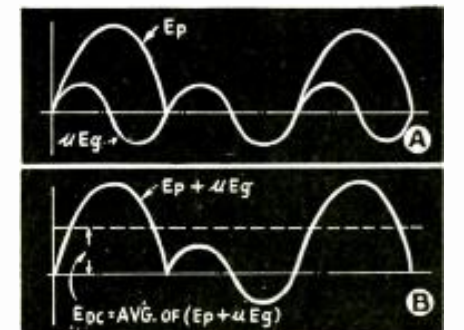

Fig. 3. The average D.C. values of I_p and E_p .

Please Say That You Saw It in RADIO-CRAFT

THE ABC OF ELECTROLYTIC CONDENSERS

(Continued from page 144)

condenser and the condenser as such becomes useless.

From the above it can readily be seen that the system exhibits the characteristics of a rectifier, and, an electrolytic condenser does not then differ in any way from the well known electrolytic rectifier.

CAUSE OF POLARIZATION

The difference in current transmissibility through the system—aluminum anode—aluminum oxide film—electrolyte—in the two directions (thus exhibiting definite "polarity") may be explained as follows:

It has already been mentioned that the oxide film is very thin, being of the order of 10^{-5} cm., so that if a potential difference of 100 V. is applied between the aluminum and the electrolyte, the field strength in the dielectric will be about 10^7 V. per cm. With such high field intensities, a cold electron emission always takes place. That is, the negative electrode emits electrons.

If we consider two plane metal surfaces or electrodes between which the field intensity F is so high that the negative electrode emits electrons, it is then found that the electron current i can be represented by an equation of the following form:

$$i = AF^2e^{-\frac{B}{F}}$$

Where A and B are constants of the materials. If it is assumed that plate A emits electrons more readily than plate B , then this means that when an alternating voltage is applied the current passes through with greater facility on one half-wave than on the other half, the greater current flowing when the plate is more susceptible to electronic emission constitutes the negative electrode.

To rectify a current, a thin layer of insulation is therefore necessary and must be bounded by two substances capable of emitting electrons to widely different degrees. If the substance which emits electrons the more easily is made the negative electrode, a higher current will flow than when it is positive.

Metals emit electrons easily and semi-conductors and electrolytes emit them with difficulty. The electrons in the electrolyte are in fact not free but are bound to ions, although the powerful electric field obtained can detach the electrons from the ions and transfer them to the insulating layer.

It is thus seen why the electrolytic condenser must always be connected in such a manner that the electrolyte is the negative electrode, for

then only will a small leakage current flow through the condenser.

CAUSE OF "LEAKAGE CURRENT"

It is also apparent that the leakage current will be the lower, the smaller the number of ions present in the electrolyte, in other words the less conductive it is.

It, now, is quite evident why it is impossible to use a second metallic electrode in place of the electrolyte. In such a case the separating layer (aluminum oxide film) would be bounded by two substances which would emit electrons with almost the same facility.

A leakage current is generated because the electrolyte is also able to emit some electrons when a powerful electric field is applied to it, such electrons migrating through the oxide film to the aluminum. This leakage current is determined by the field strength. If in condensers made of the same materials the leakage currents are the same at equal potential differences, it may be concluded that the oxide films are of the same thickness. The field intensity is then equal to:

$$F = \frac{V}{d}$$

F = field strength
 V = applied voltage
 d = oxide thickness

If an aluminum electrode is oxidized in an electrolyte and a specific potential difference V is applied, the current through the electrolyte will steadily diminish. At a certain small terminal value i , of this current, the oxidation process is considered as having been completed. Now, if a second aluminum electrode of the same dimensions is placed into the same electrolyte and a potential difference V_2 , which is double V_1 , is applied until the leakage current has reached the same final value i , it may then be assumed that in the two condensers the same field strength prevails at the oxide film. Since however, $V_2 = 2V_1$, d_2 must be $2d_1$, and hence also the capacity of the second condenser half as great as that of the first.

Thus with the same area of aluminum anode surface, we can make for example a 10 mf. condenser rated at 500 V., a 20 mf. condenser rated at 250 V., a 50 mf. condenser rated at 100 V., and so on. Thus also, in an electrolytic condenser, the thickness of the dielectric or insulating layer is always automatically matched to the potential difference.

This article has been prepared from data supplied by courtesy of Cornell-Dubilier Corp.

BUILD THE "OPEN ROAD 3" BATTERY PORTABLE RADIO RECEIVER

(Continued from page 149)

LIST OF PARTS

- One Meissner tuning condenser, 2-gang, type 15114;
- One Meissner padder condenser, 500 mmf., type 2500;
- One Meissner dial, type 18245;
- One Meissner R.F. choke, 60 mh., type 6844;
- Two Solar Domino condensers, 0.05-mf., 200 V.;
- Five Solar Domino condensers, 0.25-mf., 200 V.;
- One Solar Domino condenser, 100 mmf.;
- One Solar Domino condenser, 250 mmf.;
- One Solar Domino condenser, 0.004-mf.;
- One Solar Domino condenser, 0.002-mf.;
- One Hammarlund trimmer condenser, type APC 100;
- One Aladdin antenna coupler, type 504;
- One Aladdin oscillator coil, 2001;
- One Aladdin I.F. transformer, C100 M., 465 kc.;
- One Aladdin I.F. transformer, C101 M., 465 kc.;
- *Four grid-bias cells;
- *One cell holder, No. GB4;

- Three IRC resistors, $\frac{1}{2}$ -W., 50,000 ohms;
- One IRC resistor, $\frac{1}{2}$ -W., 10,000 ohms;
- Two IRC resistors, $\frac{1}{2}$ -W., 0.5-meg.;
- One IRC resistor, $\frac{1}{2}$ -W., 0.25-meg.;
- One IRC DPDT switch No. 22;
- One IRC volume control 75,000 ohms;
- *One 3-in. permanent-magnet dynamic speaker, type 3AMP, with transformer;
- *Two portable batteries, 45 V., No. Z30PX;
- *Two $1\frac{1}{2}$ V. cells, No. 44;
- One U.T.C. midget A.F. choke (output transformer for 1E7G will do);
- *One 10-ohm midget potentiometer;
- One Raytheon 1D7G tube;
- One Raytheon 1D5G tube;
- One Raytheon 1E7G tube;
- Three octal sockets;
- One case;
- Aluminum for chassis and panel;
- Hardware, knobs, jacks; etc.
- *Names of manufacturers will be supplied upon receipt of a stamped and self-addressed envelope.

The Best "BUYS" Are Made For Cash!*



*By "CASH" we mean your jobber's regular terms.

THERE is satisfaction as well as profit in doing business in a hard-headed way—buying on regular terms rather than getting into "tanglefoot" deals. RAYTHEONS were never sold by depression methods—that is one of the reasons why RAYTHEON sales are increasing every month. Another important reason is the uncontested high quality of RAYTHEON tubes.



ASK YOUR
RAYTHEON
JOBBER



445 Lake Shore Drive, Chicago, Illinois
555 Howard Street, San Francisco, Cal.
420 Lexington Avenue, New York, N. Y.
55 Chapel Street, Newton, Massachusetts
415 Peachtree Street, N. E., Atlanta, Ga.

We'll train YOU QUICKLY
for **Good FULL-TIME**
and **SPARE-TIME Jobs in**
ELECTRICITY



Train for a Better Job and a Future
Train in your Spare Time
by PRACTICAL Shop Methods
WITHOUT LEAVING HOME

Now, Electric Institute brings—**TO YOUR VERY DOOR**—practical training necessary for the rich rewards in Electricity. Keep your present job—no need to leave home—now you learn **ELECTRICITY** easily, practically—**RIGHT AT HOME**—in your spare time.

PREPARE TODAY FOR OPPORTUNITIES AHEAD

Get into a real money making field where there are many opportunities in Electricity. There is no better way to succeed than to **TRAIN** for work in an industry that is expanding. New Electrical projects constantly mean more jobs for men with practical training. Almost every industry uses **TRAINED ELECTRICAL MEN**. Or you can own and operate an electrical business of your own.

Opportunities to Earn Up to \$5, \$10 a Week or More While Training

With this amazingly easy, fascinating method of **HOME SHOP TRAINING** it is possible to start **EARNING MONEY** almost at once. Do not confuse E. I. Training with dry, theoretical text book courses. Electric Institute tells you exactly **WHAT TO DO—THEN YOU DO the ACTUAL JOBS with ELECTRICAL EQUIPMENT and APPARATUS** which comes with your training at no extra cost.

Become a **TRAINED man** without leaving home or your present job—then be ready to step into a **REAL ELECTRICAL JOB**.

Money Back If Not Satisfied

You must be satisfied. We give you an agreement to return every cent you pay on tuition if, after completing our training, you are not satisfied in every way with our instruction, equipment or other services given you.

With our training, our graduates receive life time consultation service, employment service and many other features to help them succeed in Electricity.

Electric Institute is ready to show you the way in the great, growing field of **ELECTRICITY**—where trained men are **ALWAYS NEEDED**. Mail coupon **TODAY**—for big, free book of facts about this revolutionary Practical Home Shop Training and the tremendous opportunities in **ELECTRICITY**.

DIESEL ELECTRIC POWER, RADIO and REFRIGERATION

Take advantage of the opportunities awaiting trained men in these and many other branches of Electricity, with **ELECTRIC INSTITUTE** practical training. Mail coupon for complete facts about **ELECTRIC INSTITUTE**—it may be the turning point in your life.

FREE
ELECTRICITY

RUSH the COUPON—TODAY—BIG BOOK FREE

H. W. Petersen, President
Electric Institute, Inc.,
Dept. 157M, Hinsdale, Illinois
Send Free Book with all facts about E. I. Home Shop Training.

Name Age
Address
City State

INTERNATIONAL RADIO REVIEW

(Continued from page 140)

wanted. Tuning by touch is primarily intended for use with sets fitted with "quiet" A.V.C. where background noise is automatically cut out, and only stations of a certain "worth-while" level of strength are permitted to get through into the loudspeaker.

Owing to the attenuation action of the A.V.C., the tuning of this type of set is inclined to be rather critical, so that it is quite easy to overshoot a station that one may be searching for, particularly in the case of a foreign program or one that has a very low value of signal strength.

Touch-tuning—preferably used with "quiet" A.V.C.—not only makes it easy to track down any given station, but it also ensures that each station, when found, is accurately tuned-in.

The new arrangement is clearly a form of automatic tuning (frequency) control, though it is distinguished from the ordinary type of A.F.C. by the fact that the "check" or control is applied directly to the tuning-shaft, instead of to the local-oscillator circuit.

A special brake "control" tube (V, Fig. 2A) is used, which, so long as there is no signal coming in, is biased to the cut-off point. On the arrival of a signal, the bias is removed by the action of the A.V.C. attenuating circuit, and a current is passed from the tube to the windings of an electro-magnetic brake.

The brake, as shown in Fig. 2B, consists of a U-shaped magnet mounted close to one side of the tuning-disc. The magnet is provided with a winding which normally carries no current, so that the disc is free to rotate. When a signal comes in, the current released by the brake-control tube, as already explained, passes through the windings and so energizes the magnet.

An armature is then attracted by the pole pieces and serves to lock the disc firmly in position. The armature is loosely pivoted on a back plate (shown shaded), and normally hangs free, so that there is sufficient clearance between it and the edge of the disc to allow the latter to rotate. But when the magnet is energized the armature swings in towards the back plate and jams the disc against further movement.

As shown in Fig. 2A, the locking action of the brake is made more effective by inserting a friction drive between the control knob and disc. The brake then holds the disc in the required position, even if considerable force is applied to the knob, because the friction drive simply slips.

For rapid retuning, the knob is pushed slightly inwards against a spring to close the switch contacts Sw.1. This applies a high negative bias to the grid "control" tube V and so shuts off the supply of current to the windings of the brake.

The operation of the brake control tube is shown in the simplified circuit of Fig. 2A. When no signal is being received, the grid bias of the tube is taken from the point B, which is sufficiently negative to prevent the tube from passing any current.

As soon as a signal comes in, the A.V.C. voltage from one of the other tubes in the set (not shown) causes the potential of the point A to rise (i.e., become less negative). This rise in potential is transmitted across the condenser C1 to the grid of V, and so enables the latter to pass current through the line to operate the brake magnet.

The potential of the point B is, however, sufficiently negative to "choke" the tube again, after a certain time, even when the signal is tuned-in. Accordingly, after an interval, of the order of a few seconds, the output current from V is again cut off, and the brake is automatically released, ready for the listener to pass on to another program should he wish to do so.

After each operation of the brake, a small reverse current is automatically passed through the magnet windings, in order to wipe out any residual magnetism which might otherwise tend to make the brake "sticky" in action.

TINY GERMAN TRANSMITTER EXPLORES STRATOSPHERE

GERMAN SCIENTISTS, according to a recent issue of *Funk-Technische Monatshefte* (Berlin), recently developed a tiny transmitter which, when attached to a balloon and sent

aloft, automatically transmits meteorological data concerning the stratosphere. The transmitter which, with all batteries, weighs but 2½ lbs., operates on a wavelength of 45 meters, using a ¼-wave dipole antenna. The rubber balloon, weighing 3½ lbs., is so constructed, that at a height of approximately 30,000 meters (approximately 100,000 ft.) it bursts, automatically converting itself into a parachute and floating the transmitter safely to ground.

The transmitter uses the well-known Hartley shunt-feed circuit, with a maximum "B"-supply of 30 V.

It is interesting to note that all components of the circuit, with the exception of the variable condenser, are enclosed in an evacuated glass tube, so as not to be affected by atmospheric conditions!

Sending Temperature Indications. The rotor of the variable condenser is connected to a bi-metal thermostat so that, with a change of temperature (as the balloon ascends), the carrier of the transmitter changes its frequency.

Sending Barometric Indications. The height of the balloon is ascertained by means of a barometer which, through the medium of 2 contact wheels to which it is connected, interrupts the plate supply at regular intervals (thereby causing the transmitter to stop functioning temporarily). In other words, for each (pre-determined) given number of feet which the balloon ascends the transmitter will "click-off" for a short period and then go on again, repeating this operation regularly as the altitude increases.

A special short-wave receiver is utilized to intercept the signals from the transmitter. The tuning dial of this receiver is calibrated in temperature units, so that when the dial is turned to adjust for the frequency "drift" of the transmitter, the temperature of the atmosphere at any given height can be directly read. Similarly, a given number of "clicks" in the headphones will indicate the exact height of the balloon.

Referring to Fig. A, No. 1 is a metal cylinder, open at each end, containing the bi-metal thermostat; No. 2 is a hardrubber container containing the variable condenser; No. 3 is the evacuated glass tube containing components of the circuit; No. 4 are the contacts for interrupting the plate supply; No. 5 is the battery compartment; Nos. 6 and 7 are the 2 sections of the dipole antenna.

Incidentally, the batteries are specially constructed to withstand a temperature of -76 deg. Fahrenheit. See Fig. 1, for schematic diagram of the circuit.

HOW TO MAKE "THE SEAFARER" LOOP-TYPE BOAT RADIO SET

(Continued from page 169)

- *One phone jack for loop plugs, type 1;
- *One phone jack, type 3A (optional) for headphone;
- *One pilot-light mounting, type 330 (for P.L.);
- *One instrument-type vernier dial, type 296;
- *Six knobs, type 294;
- *One knob, type 286;
- *Two plates, type 274;
- *One tuning "eye" assembly, PF6;
- *Two sockets, RSS-8;
- *Four sockets, SS;
- *Two 2-post assemblies, A-G, and one 2-post speaker assembly;
- Cabinet and chassis (as per specifications);
- Two National Union type 6K7 tubes, V1, V3;
- Four National Union tubes, one each of types 6A8, 6Q7, 6F6, and 6C5, V2, V4, V5, V6 (respectively);
- One National Union type 6E5 visual tuning indicator, or "eye", V7;
- *Special R.F. hookup wire (q.s.);
- One pilot lamp, 6.3 V., P.L.;
- Loop materials (per specifications in Part II), etc.
- *Names of manufacturers will be supplied upon receipt of a stamped and self-addressed envelope.

In October RADIO-CRAFT!
New circuit developments in the latest radio receivers!

Please Say That You Saw It in RADIO-CRAFT

COSMIC RAYS SHORTEST WAVELENGTH IN THE WORLD

(Continued from page 141)

within such a closed vessel, under the influence of ether waves there is a production of ionized atoms which make the contained gas a conductor whose resistance varies with the intensity of the ether waves.

CONSTRUCTION OF ONE TYPE OF COSMIC RAY METER

The cosmic ray meter to be described was designed by Dr. A. H. Compton, University of Chicago, and Dr. R. D. Bennett, Massachusetts Institute of Technology for the Carnegie Institution of Washington.

The meter—shown as insert in the large photograph, pg. 141—consists of a spherical steel ionization chamber (see cross-section drawing) 13 ins. in dia., filled with argon gas at 50 times atmospheric pressure. Surrounding this chamber is more than a ton of lead shot contained in an outer steel sphere 28 ins. in dia. This shield of lead 15 ins. thick is easily penetrated by cosmic rays, but effectively excludes any radiations of longer wavelength that may exist locally due to radioactivity of the earth or air. The cosmic rays ionize the compressed argon gas within the steel chamber permitting an electric current to be passed through the gas when a high voltage is applied between the sphere and its internal collecting electrode.

In order to cancel the variation in ionization produced by changes in barometric pressure and in temperature, a small amount of uranium is introduced into the ionization chamber. Uranium radiates beta rays. A shield of brass, which the beta rays cannot penetrate, prevents these rays from affecting the cosmic ray electrodes. The beta ray chamber is filled with the same argon at the same pressure and temperature as the cosmic ray chamber. Also the electrodes in the beta ray chamber have the same voltage applied as those in the cosmic ray chamber. So we have two ionization chambers, one within the other,

the inner having a definite rate of ionization fixed by the quantity and position of the uranium, the outer having a rate of ionization varying in accord with the cosmic ray intensity. Pressure, temperature and applied voltage are the same for both chambers. By balancing the ionization current from one chamber against that from the other, all effects due to variations in pressure, temperature and applied voltage are cancelled and the remainder represents only the variations in cosmic ray intensity.

These variations are recorded by means of an electrometer upon a film which is moved slowly by clockwork. At the same time the film records variations in barometric pressure and in temperature.

Seven of these cosmic ray meters (it is the last of these which is here illustrated) have been constructed and are located as follows:

- (1) Magnetic Observatory, Cheltenham, Maryland.
- (2) Huancayo, Peru (Elevation 11,000 ft.).
- (3) Christ Church, New Zealand.
- (4) Mexico City (Elevation 7,500 ft.).
- (5) Godhaven, Greenland.
- (6) Mt. Evans, Colorado (Elevation 16,000 ft.).
- (7) On deck of the S.S. Aorangi plying between Vancouver and Australia.

These meters will provide permanent registration of cosmic ray intensity fluctuations at widely separated stations over the globe during the next 10 to 15 years. The data so collected will be analyzed to study the effect of various electrical, meteorological and astronomical factors on cosmic ray intensity.

It is thought that cosmic rays indicate that here and there at many places in the universe, wherever suitable conditions prevail, there is in progress a building up of heavier elements from lighter ones, offsetting the disintegrating processes of radioactivity, where heavier elements break down into lighter ones.

"If this suspicion be confirmed," says Millikan, "it will constitute new proof that this is a changing, dynamic and continuously evolving world instead of a static or merely disintegrating one, and that the cosmic rays, which increasingly shoot through space in all directions, are the announcements sent out through the ether of the birth of the elements."

This article has been prepared from data supplied by courtesy of National Carbon Co., Inc.

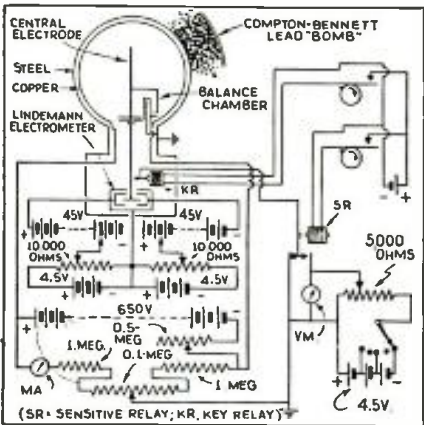

Electrical connections inside the "bomb"; and distribution of the numerous external batteries.

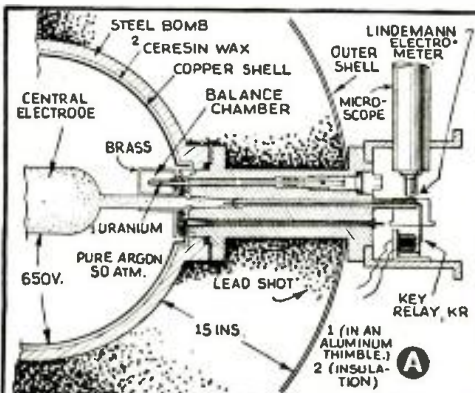

At A is shown a close-up cross-section view of the steel "bomb", its lead sheath more than a foot thick, and the electrometer; the readings of the latter are photographically recorded. At B is shown this electrometer in its schematic form. (Thanks are extended to *Review of Scientific Instruments* for a portion of these data.)

SPECIAL NOTICE

The October TEST EQUIPMENT NUMBER of *Radio-Craft* will contain information, about new tubes, which you must have to "keep tabs" on what's new in electronic devices.

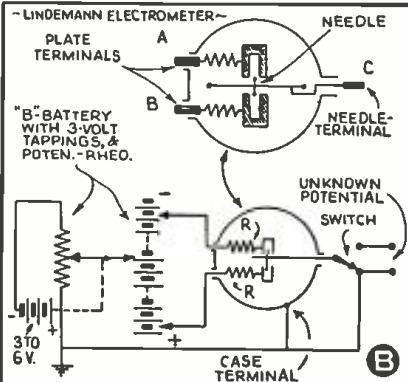

Your Model
"772"

fits here—in this lightweight, solid-wood combination carrying case with real luggage handle... along with—

This New Model
"773"

Tube Checker... which matches your "772"... giving you a complete, modern, servicing combination.

Simply mount your Model "772" Analyzer in this handsome, combination carrying case along with the matched Model "773" Tube Checker, and you have the most modern, up-to-the-minute servicing unit available. Model "773" represents the last word in tube checkers... in design... in operating characteristics... in simplicity and dependability! But if you don't own Model "772"... purchase the complete unit (Model "775" SERVISSET). Be set for better business in the active season ahead... be able to service sound movies, P.A. systems, electronic circuits and television, as well as all receivers. Have a servicing unit that will enable you to get the profits from all these sources, and one that will remain serviceable and dependable for years to come. Be sure to get complete information. Return coupon.

Remember...

WESTON Instruments

can be purchased under the WESTON INVESTMENT PLAN.

Weston Electrical Instrument Corporation
599 Frelinghuysen Avenue, Newark, New Jersey.
Send data on Models 773, and 775 combination.

Name _____
Address _____
City _____ State _____

Please Say That You Saw It in RADIO-CRAFT

"We're with Centralab all the way!"



-says EASTERN AIR LINES



"Centralab variable resistors have been giving very satisfactory service in our ground station and aircraft applications. We find them dependable and economical for many varied applications in our communications equipment."

DON C. McRAE
Supt. of Communications.

Old Man Centralab takes to the air with the finest recommendations... with a pilot's license for smooth-frictionless performance.

Schedule your replacement work with Centralab Controls. Smooth—certain attenuation plus long life and absolute customer satisfaction are definite.

Get the 1937 Volume Control Guide

Centralab

MILWAUKEE WISCONSIN

BRITISH CENTRALAB, LTD.
Canterbury Rd., Kilbourn
London N.W. 6, England

FRENCH CENTRALAB CO.
118 Avenue Ledru-Rollin
Paris XI, France

Save Money on everything you buy...



The New BARGAIN BULLETIN

Your Guide to Hundreds of Outstanding Values.

FREE Write today for this outstanding new BARGAIN BULLETIN—there is no obligation on your part. High quality merchandise at sensationally low prices! Radio Sets, Parts, Sporting Goods, Watches, Clocks, Typewriters, Cameras, Novelties and many other items at real savings to you. Fair Dealing—Prompt and Courteous Service, always. Send for your Free BARGAIN BULLETIN now, try us, and be convinced of our superior values and service.

RADIO CIRCULAR CO., INC.
DEPARTMENT RC
315 Broadway New York, N. Y.

ORSMA MEMBERS' FORUM

(Continued from page 164)

tube—octal base or otherwise—should not function exactly the same regardless of whether or not it is shielded. The fault of short filament life, if such it is, must be traced to other "causes" than the existence or non-existence of shielding.

What do our other readers have to say on this point? Perhaps Canadian Radio Corp. has some interesting technical information concerning spray-shield tubes which they would like to have Radio-Craft pass on to Canadian Service Men.

bers' kinks, gossip and service notes in the Members' Forum I will venture to explain some notes that might help other members. First is the Silvertone model 111. The set would motor-boat and squeal, yet test all OK.

I tried different condensers and chokes on detector plate circuit and tested for open R.F. coils, defective tubes and improper shielding. Next, I removed the tuning condenser cover. At each condenser there is a tension spring which fits over the condenser shaft. The ground side of the grid coils is soldered to these springs. Remove spring by lifting out bottom end. Clean springs thoroughly where they make friction with the condenser shaft and bend each spring to give a little more tension before replacing.

(Continued on page 189)

SERVICE HINTS BY A FELLOW MEMBER

RADIO-CRAFT, ORSMA, Dept.:

As an ORSMA member, and seeing other mem-

READERS' DEPARTMENT

(Continued from page 164)

A PAGE FOR EXPERIMENTERS?

Raleigh, North Carolina:

How about giving we experimenters a page in your radio magazines, where we may discuss our undeveloped theories?

For instance, I have devoted over 6 years developing a superheterodyne that incorporates a feature that, so far as I know, is new and unique in that I have at last learned how to increase selectivity and retain the complete audio-component. In other words, I've carried the reception of amplitude modulated signals to its obvious conclusion.

I can't see how everyone overlooked the simple little requirements necessary. Somehow they have, and I stumbled on it after wasting time and money for years on crystal filters, special I.F. transformers, etc.

Needless to say, the stability of the oscillator

tube in the converter is the only limiting factor in the whole receiver.

I don't think my idea patentable but it is the third really big forward step in the art of receiving what the ether has to offer.

Now that I've got this idea, I want to know what to do with it.

ALTON B. ASKEW

We would appreciate hearing from other experimenters regarding the question of devoting a page in Radio-Craft to experimenters.

ELECTRICAL GUITAR VIA EARPHONE PICKUP

Milton, Nova Scotia:

I would like to describe an experiment I made recently with an earphone.

(Continued on page 186)

RADIO WITTIQUIZ

(Continued from page 164)

- | | | |
|-------|------|------|
| (1c) | (4c) | (7c) |
| (2d) | (5d) | (8b) |
| (3d2) | (6a) | (9a) |

Contest Rules

- (1) An award of a 1-year subscription to Radio-Craft will be given to each person who submits a WITTIQUIZ that the editors consider suitable for publication in Radio-Craft.
- (2) WITTIQUIZZES should be typed, or, clearly written in ink; use only one side of paper.
- (3) Submit as many WITTIQUIZZES as you care to—the more you submit the more chance you have of winning—but each should be good.
- (4) Each WITTIQUIZ must incorporate humorous elements, and must be based on some

term used in radio, public address or electronics.

(5) All answers must be grouped, by question number and correct-answer letter, on a separate sheet of paper.

(6) All contributions become the property of Radio-Craft. No contributions can be returned.

(7) This contest is not open to Radio-Craft employees or their relatives.

(8) The contest for a given month closes on the 15th of the 3rd month preceding magazine-issue date. (For instance, contributions to November, 1937, Radio-Craft, on the newsstands about Oct. 1, must be received at Radio-Craft editorial offices not later than Aug. 15th, 1937.)

Get your friends to help you make "Witti-quizzes"!

DIRECTIONAL BEAM ANTENNAS IMPROVE BROADCASTING SERVICE TO LATIN-AMERICAN LISTENERS

The success of directional antennas for long-distance, short-wave broadcasting is proved by the favorable reports received from widely-separated places in Pan-American countries. The directional-beam antennas are so constructed that they produce the same effect of a 6-fold increase in power. The South American antennas consist of wires having the shape of a large V, with the apex supported on a 250-ft. steel tower. The 2 ends are supported by 165-ft. wooden poles.

At W3XAL (Bound Brook, N. J.) 4 antennas, in 2 groups, are used for the international broadcasts. Two more antennas on the same site are non-directional. The directional are of the horizontal-V type, and have shown remarkable efficiency. Station W3XAL operates with 15 to

35 W. on 2 frequencies, viz.: 16.87 and 49.18 meters.

RADIO COMPANY ABSORBS OVER 700 COLLEGE STUDENTS

Schools and colleges from Maine to California are represented in the group of more than 700 college graduates who at the close of the present academic year have started moving into the General Electric Co. These graduates have taken their places in various departments of the company, notably, in the Test Department and the Business Training Course.

To the Test Department have come more than 500 men from 120 different schools throughout the nation. The majority of this group are electrical engineers. About 150 are mechanical, industrial, chemical and metallurgical engineers and physicists.

More than 200 graduates have been taken into the Business Training Course. These men will be absorbed into the organization after a period of training.

Please Say That You Saw It in RADIO-CRAFT

the AMPERITE VELOCITY

with NEW DESK STAND

Ideal for desk, pupil, footlights, bouquets Leaf spring suspension acts as shock absorber **STAND ONLY** LIST \$4.00 **NAME PLATE** with call letters . . . LIST \$2.00

MICROPHONES: Model RBHn (High Imped.); or RBMn (200 ohms) with cable connector & switch . . . LIST \$42.00 Models RBSn, RSHn, with switch only . . . LIST \$32.00

NEW "HAM MIKE"

No Peaks! No Splashing! Real Broadcast Quality! RF Choke Circuit included in microphone. Output, -68 db. Operates directly into grid. **MODEL HAM** (High Imped.) or **MODEL HAL** (200 ohms) . . . Gunmetal. LIST \$22.00, Chrome LIST \$23.00. Price includes Ham Desk Stand, Call Letters, and 6 feet of cable.

MODEL RAL \$22.00 LIST

A popular Amperite Velocity of very high excellence. Used for both speech and music. No peaks. Flat response over audible range. Output, -68 db. Triple shielded. Shock absorber, swivel bracket. **MODEL RAL** (200 ohms); or **MODEL RAH** (2000 ohms) high impedance . . .

FREE: Window Decal & Window Display

AMPERITE G. 561 BROADWAY, N. Y.

AMPERITE Velocity MICROPHONE

SPORT BINOCULARS

THESE Temple-Type Sport Glasses are the lowest-priced Binoculars ever offered. Nothing new for the sportsman, Rancher, Traveler, Theatre-goer, Sightseer, Ideal for Prize fights, Football games, Box office, Football games, Regattas, Rifle ranges, Track events, Tournaments, Arenas, Movies, Music Halls, Theatres, Operas, etc.

CAN BE WORN LIKE SPECTACLES!

Great for Indoor or Outdoor Sports, Vacation trips, Hunting, Fishing, Exploring, Aviation, Sojourns, Ocean Travel, Mountain Climbing, Yachting, Boating, Hiking, Motoring, Camping, etc. Very clear and powerful in defining distant objects. Handsome in appearance. High grade 3-power objective lenses of good optical quality with wide field of vision. Individual focusing; eyepieces adjustable for eyes of unequal vision. Best mechanical construction. The frame is of durable black composition; comfortable fitting; lightweight temples, and nose bridge.

STOCK NUMBER: \$200. SPORTS BINOCULARS, Your Price \$249

Sent postpaid anywhere in U. S. A.
Money back Guarantee

WELLWORTH TRADING CO.
Dept. RC-937
560 W. WASHINGTON BLVD., Chicago, Ill.

RADIO CHASSIS CRADLE

For more profitable and quicker servicing, testing and repairing of receivers or amplifiers, every radio service shop needs the **RADIO GIMBAL** (chassis cradle). Equipment clamps to cradle which can be adjusted to any desired angle. Conveniently accommodates any chassis up to 13 x 21 inches. Excellent for displaying receivers to customers.

Write for illustrated circular RC1
WM. A. THOMAS CO. 321 CAROLINE ST., NEENAH, WISCONSIN

RADIO ENGINEERING

RCA Institutes offer an intensive course of high standard embracing all phases of Radio. Practical training with modern equipment at New York and Chicago schools. Also specialized courses and Home Study Courses under "No obligation" plan. **Catalog Dept. RT-37.**

RCA INSTITUTES, Inc.
A Radio Corporation of America Service
75 Varick St., New York 1154 Merchandise Mart, Chicago

A 120-WATT "CATHODE-DRIVE" HI-FI AMPLIFIER

(Continued from page 159)

age drop across the primary of the input push-pull transformer. This raises the effective bias and is equivalent to inserting a voltage opposite in phase to the original signal voltage. Of course, the exact bias is determined by the D.C. resistance of the primary and the auxiliary bypass resistance. The voltage fed back in inverse phase is determined by the impedance ratio of the primary to the total cathode circuit impedance. This design may be varied to produce any desired percentage of inverse feed-back. Naturally, the advantages of using a cathode-circuit driver transformer are also realized in this first stage.

SEPARATE VOLTAGE SUPPLIES

In order to keep the plate and screen-grid voltage regulation within ideal limits, 2 separate transformers are supplied, one of which (P.T. 1) is equipped with 2 high-voltage windings. One of these windings, in conjunction with 2 type 83 rectifiers, supplies the output tubes with their required voltages. The other winding supplies plate voltage for the input tube and both push-pull drivers.

An additional transformer (P.T. 2) supplies all necessary heater current and filament voltages for all rectifiers. A mercury vapor 83 rectifier is used to supply bias in order to keep the grid-circuit impedance as low as possible. It will be noted that a heavy bleed-resistor is employed so as to prevent undue grid-circuit distortion in the power output stages.

A relay is inserted in the bias supply circuit so as to avoid the possibility of applying plate voltage to the power output tubes before the required grid bias is established.

INPUT AND OUTPUT CIRCUITS

In order to increase the flexibility of the amplifier, a specially-designed, balanced-input transformer is utilized, so as to provide for simple connection to the output of any conventional power amplifiers or voltage amplifier. A center-tap is employed to enable the balancing of long 500- or 250-ohm lines. This is some-

times necessary when telephone lines are run into the amplifier. A high-impedance input terminal is also provided to facilitate connections directly to plate circuits of preceding stages.

In order to avoid undue losses in the output circuit, 2 universal transformers are utilized, each one of which is provided with 500/250/16/8/4/2-ohm output terminals. This terminal arrangement provides for the use of any number or type of speakers for each one of the output channels.

In order to help the operating technician to keep check on the driver or power output tubes, 3 jacks are provided on the front panel so that a 0/500 ma. meter may be connected into the supply circuits of any one of these pairs of tubes. Undue power tube deterioration may be rapidly detected by noting any marked changes in plate current.

The general design of the amplifier follows the requirements set up for good class AB design, and the technician who desires to construct this power amplifier, should bear in mind that the transformers are among the most vital units in the amplifier and must be properly designed if true, high-fidelity performance is expected. The schematic diagram of the amplifier is shown in Fig. 1.

The author will be pleased to answer all questions addressed to him in care of *Radio-Craft*.

LIST OF PARTS

- Power transformer.—International Transformer Co.;
 - Audio transformers.—International Transformer Co.;
 - Filter chokes.—International Transformer Co.;
 - Filter condensers.—Solar Mfg. Co.;
 - Cathode by-pass condensers.—Aerovox Corp.;
 - Resistors.—International Resistor Co.;
 - Tubes (glass or metal)—RCA Radiotron or Sylvania;
 - *Relay;
 - Basic foundation kit—Amplifier Co. of America.
- *Names of manufacturers will be supplied upon receipt of a stamped and self-addressed envelope.

BUSINESS PROBLEMS OF THE SERVICE MAN

(Continued from page 145)

The people in this section could not pay much for repairs because of their small earnings. This meant low profits. When profits are low a large volume of business must be obtained. To do a large volume of business a large stock must be carried.

I will present the most optimistic views for this man's chance for success.

In all cases where business rentals are concerned at least one month's security is demanded. The telephone and electric companies require service deposits. Light fixtures, shelves, counters are needed and the store must be painted. Some test equipment is required, at least a tube checker and volt-ohm-milliammeter. Parts and tubes are required as stock.

- The initial investment is as follows:
- \$70 First month's rent and security
 - 10 Telephone security
 - 10 Electric security
 - 100 Fixtures, shelves, counters, etc.
 - 15 Condensers, resistors, etc.
 - 25 Tubes, a reasonable quantity
 - 10 Initial advertising
 - 20 Inexpensive tube checker
 - 15 Inexpensive A.C.-D.C. volt-ohm-milliammeter

\$275 Total

These figures, outside of the rent, are very low. The security amounts to the telephone and electric companies are below requirements. It is assumed that the party concerned will buy the lumber, electric fixtures and paint, and do all the labor himself. Everything is extremely conservative and from his initial capital of \$300 he has \$25 left to live on. It is the height of optimism, to figure that a new store will show a profit the first 3 months.

The monthly overhead, then, very conservatively is as follows:

- \$35 Rent

- 5 Light
- 5 Telephone
- 100 Salary (\$24 per week)
- 5 Advertising

\$150 Total expenses per month

Based on a 40 per cent gross profit, the daily receipts must equal \$15 a day, every day, for a 25-day business month. These figures do not allow for a drawing account for his wife—*she works without salary.*

Now dear embryo Service Man would you give up a \$24 a week job to go into business under these conditions? The answer is very apparent.

The advice on this man's problem was to hold on to his present position. In his spare time he could build up a following and save a sufficient amount of money as a reserve fund. He would then be in a financial position to open a store in a good business section and for a short time not be dependent upon the income of the business for his living expenses.

Write to "Jack," tell him your problems, let him advise you on your next move; if your capital is limited, he can help you.

It's Easy! . . . It's Fun!

See the new WITTYQUIZ contest on page 164.

Everyone can win a FREE SUBSCRIPTION TO RADIO-CRAFT FOR 1 YEAR.

HI-VOLTAGE POWER FROM A STORAGE BATTERY

(Continued from page 158)

power transformer, the center-tap of which is connected in series with the 6 V. storage battery and the 2 movable tungsten contacts (see Fig. 1). Due to the "chopping" of the battery current by the 2 sets of contacts, 6 V. of pulsating D.C. is present in the primary winding. By employing properly designed power transformers, this 6 V. pulsating D.C. can be stepped up to any desired alternating current voltage, even as high as (or more than) 10,000-20,000 V. A.C., necessary for the operation of mobile neon signs.

DESIGN PREVENTS STICKING CONTACTS

The method of "vibrating" the contact arms and the construction of the contact arms themselves are entirely different from those of auto-set vibrators. In an auto-set vibrator, an electromagnetic solenoid is employed to vibrate the light-gauge springs onto the ends of which small-diameter tungsten points are welded, or riveted. Occasionally, such devices tend to "stick," and the vibrator spring (being necessarily highly flexible to permit magnetic attraction of the armature) is not sufficiently powerful to pull them apart. This also happens if the points are operated beyond their maximum rated output.

Now let us see wherein the stor-bat has overcome both the "sticking" and the replacement problem. Even though this new unit employs contact arms equipped with extra-heavy tension springs (to provide perfect surface contact and resulting minimum of contact surface resistance, as well), with this new device the motor and eccentric cam (in place of the solenoid) will break the contacts apart even though the tungsten points were considerably over-loaded. Therefore, uninterrupted service is definitely assured; as well as increased power output. A valuable feature is the constructional design of the 2 pairs of contact arms permitting instantaneous replacement at low cost, of any one or all, should the tungsten points wear.

COMPARATIVE EFFICIENCY

The motor itself consumes 1.9 A., exclusive of the load applied to its tungsten points, if the full rated output of 65 W. is applied, then the total current consumption is 10.5 A. (for the 65 W.) plus 1.9 A. (for the motor), in all 12.4 A. drain from a 6-V. storage battery. Therefore, if the power supply requirements in an amplifier call for 300 V. at 120 ma. (36 W.), for instance, the total drain on a 6-V. storage battery would be 1.9 A. plus 6 A., in all 7.9 A. as compared to 10 A. drain required by a dynamotor. When a 12-V. unit is employed at its full rated output (130 W.), the total battery drain is 11 A. (for the 130 W.) plus 1.9 A. (for the motor), in all 12.9 A.

The elimination of sparking at the contacts not only tends to considerably lengthen the life of the tungsten points, but also minimizes to a marked degree the interference generally present in high gain amplifiers or radio receivers. To completely eliminate such interference, a filter is available which can be connected externally.

OPERATING DETAILS

If this device is to be operated adjacent to a microphone, care must be taken to insulate the

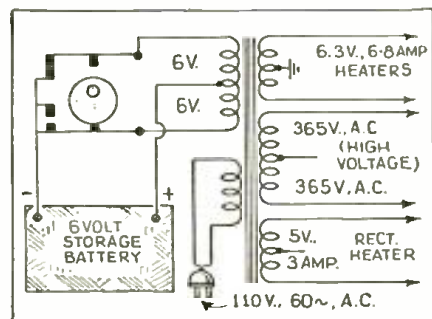

Fig. 2. Transformer wound with both 110-V. and 6-V. windings; hence useable with Stor-Bat or on A.C. Note that this is only the basic, theoretical circuit.

drone of the motor as well as the tapping sound produced by the contacts. Models are available ready mounted within double metal cases, each lined with sound-deadening sponge rubber.

When tubes are heated from the car battery, one leg is directly grounded, as no center-tap winding is employed. For dual-powered operation (i.e., 6 V. D.C. and 110 V. A.C.) provisions must be incorporated to isolate this ground to one leg of the heaters, and to employ instead a grounded center-tap 6.3 V. filament winding.

Referring to Fig. 1, it will be noted that the center-tap of the 83 filament winding is connected in the usual manner to a filter choke input (condenser-choke input is also permissible). From there on, the rest of the circuit is conventional.

All that is required to enable the operation of an amplifier from both 6 V. D.C. and 110 V. A.C. is an additional primary designed for 110 V. A.C. input and an additional secondary of 6.3 V. A.C., 6-8 A., for the amplifier tube heaters (see Fig. 2). The balance of the amplifier remains unchanged. Means of course must be provided to switch on and off either the 6 V. source, or the 110 V. A.C. source, and further means must be provided to ground one leg of the amplifier tube heaters when 6 V. battery operation is employed, and then to remove this ground connection when the center-tap of the 6.3 V. filament winding is employed during 110 V. A.C. operation.

The stor-bat is unusually compact, the essential unit (minus sound insulation cases) measuring 4 x 4 3/4 x 3 1/2 ins. high. (When enclosed in its 2 sound-insulating cases, the over-all dimensions are 6 1/2 x 3 3/4 x 3 3/4 ins. high.)

The writer would be pleased to answer any questions relating to this device or to furnish more specific information concerning its adaptability to individual requirements.

This article has been prepared from data supplied by courtesy of Stor-Bat Power Devices Co.

KENYON

EFFICIENT

RELIABLE

MODERN

LOW PRICED



KEN-O-DRIVE

The MODERN Answer to Critical Driver Operation

KEN-O-DYNE

The RELIABLE Method of Matching OUTPUT TUBES TO SPEAKERS

KEN-O-LINE

The EFFICIENT Coupling Device From Universal Line

Ask Your Dealer For Our 16 Page "T" Line Catalog Which Contains One Of The Most Complete Lines of Audio and Power Components Ever Presented. Also Contains A Large Selection of Modern Audio Circuits.

KENYON

TRANSFORMER CO., Inc.
840 Barry St., New York, N. Y.
Export Dept., 25 Warren St., New York, N. Y.

THIS POCKET VOLT-OHM-MILLIAMMETER DOES ALL YOUR D.C. TESTING

PRECISION BUILT \$10.80

Model 735 has a Triplett D'Arsonval type precision instrument with easily readable scales. Ranges are 15-150-750 volts at 1000 ohms per volt; 1 1/2-15-150 M.A.; 1/2-1000 low ohms; 0-100,000 high ohms at 1 1/2 volts. Provisions for external batteries for higher resistance measurements. Has selector switch for all ranges and individual zero adjustment for resistance measurements. Now with etched panel.

ASK YOUR JOBBER — WRITE FOR CATALOG

READRITE METER WORKS
916 College Dr., Bluffton, Ohio

Without obligation please send me more information on Model 735. I am also interested in

Name

Address

City State



MODEL 735
ACCURACY 2%
MOLDED CASE BATTERY TEST LEADS AND ACCESSORIES INCLUDED

Please Say That You Saw It in RADIO-CRAFT

STORAGE • BATTERY • OPERATED STOR-BAT POWER SUPPLIES

- Motor driven mechanism eliminates contact point "sticking"
- Tungsten contact point equipped arms may be replaced within five minutes
- Far more efficient and versatile than a dynamotor
- 6 Volt models can produce 110 volts A.C. 65 watts, or, from 250 volts D.C. at 200 mils to 500 volts D.C. at 100 mils
- 12 Volt models can produce 110 volts A.C. 130 watts, or, from 250 volts D.C. at 400 mils to 500 volts D.C. at 230 mils
- Especially suitable for Dual Powered (D.C. & A.C.) Operated Amplifiers!
- AC Models suitable for Truck Neon Signs!

Write for Descriptive Literature!
STOR-BAT POWER DEVICES CO.
693 Broadway, New York, N. Y.

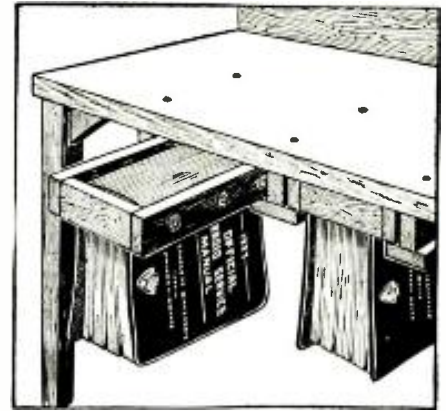

FILING SERVICE MANUALS

Service manuals, being constantly used in the shop soon become worn and frayed . . . but not if this system of filing is used. This practical method has been adapted from an item which appeared in a recent issue of *Electrical Merchandising*.

FREE!! New 1938 Radio Catalog

Servicemen—Radio Salesmen and Agents—become a MODELL representative in your community. Earn up to \$100 a week in commissions selling Nationally Known Radios. Take orders from the largest and most complete catalog ever published, describing and illustrating the following makes: RCA—Philco—GE—Zenith—Motorola—DeLoe—Grunow—Crosley—etc., etc. Join this nation wide organization by writing for particulars to day. No obligation. State what you are doing.

Write to Dept. D-4 and mail to address nearest you.

Modells Since 1889
AGENCY DIVISION

CHICAGO, ILL. ATLANTA, GA. NEW YORK, N. Y.
56 W. Washington St. 57 Forsyth St. 58 Cortlandt St.

THE NEW L&L MODEL WL

TESTS ALL TYPE TUBES

Semi-Ballast Tube Tester

NEON short leakage test. LINE VOLTAGE REGULATION. 8 Toggles allow test of any or all elements. FILAMENT RETURN SELECTOR. Ballast circuit allow even correct tube readings. Can be adjusted to test tubes where there is no power. Etched metal panel. 10 days trial, money refunded if not satisfied.

L & L ELECTRIC CO., 350 MADISON AVE., MEMPHIS, TENN.

AN EASILY-BUILT SHORT-WAVE SUPERHET "5"

(Continued from page 150)

at this frequency in the 6K7 tube. Next, the 6C5 acts as detector, changing the signal to an audio frequency. *Regeneration is added to this portion of the circuit, resulting in an increase in selectivity and sensitivity, over the value usually obtained with a single I.F. stage, to a value more near that resulting with 2 I.F. stages.*

In addition, regeneration makes possible the reception of C.W. signals; this 1 tube, then, actually performs the function of an added I.F. tube, detector, and beat oscillator.

REGENERATION AND TUNING CONTROLS

The regeneration control will be found very smooth and absolutely noiseless in operation; further, and most important, it has positively no effect on the tuning of the set. Once set for either phone or C.W. reception, it need not be touched. Changing coils or tuning the set does not necessitate continual adjustment of this control, as is the case in T.R.F. regenerative receivers.

Tuning is smooth, and any band of frequencies, either short-wave broadcast or amateur, may be spread out on the main tuning dial. The band is selected by setting the *oscillator tank condenser, C2*, to the middle of the band desired, and adjusting the *antenna tank, or band-set, C1*, as you would a trimmer condenser, for maximum signal strength. The coil values have been so adjusted that if the coils are wound as specified, in Fig. 2, the antenna and oscillator tank condensers will be found to track very closely. Of course, the actual tuning from station to station is accomplished by means of the small condensers, C, driven by the vernier dial.

A switch is incorporated for breaking the negative lead of the D.C. power supply. This switch serves as a "stand-by" switch, when the receiver is used for communications purposes.

While most signals will provide satisfactory reception by means of the speaker on the front panel, a jack, J, is arranged for headphones. When phones are plugged-in, the speaker is silent. Thus you can listen in the wee small hours of the night without disturbing the whole household.

A large 3/4-in. rubber grommet is mounted in the hole provided for the phone jack, to prevent shorting of the high voltage to the metal chassis.

The chassis and panel may be easily formed and punched, using either 14-gauge aluminum, or electrolyt, or both the front panel and chassis base may be procured already punched, chilled and formed.

LIST OF PARTS

- One punched and drilled base, 7x11x2 ins.;
- One punched and drilled panel, 7x12 inches;
- One condenser mounting bracket;
- One regenerative I.F. coil;
- One set of four oscillator coils;
- One set of four antenna coils;
- One Meissner 456 kc. input I.F. transformer;
- One Meissner 456 kc. output I.F. transformer;
- One 2.5-mhy. R.F. choke;
- Two Hammarlund "Star" 140-mmf. tuning condensers;
- Two Hammarlund 20-mmf. tuning condensers;
- One Hammarlund flexible condenser coupling;
- *One 3-in. vernier dial;
- *One 2-in. dial plate;
- *Four bar knobs;
- *Seven 0.1-mf. 400 V. tubular condensers;
- Two 25 mf. 25 V. condensers;
- One 8-8 mmf. electrolytic condenser;
- One 100 mmf. mica condenser;
- One 300-ohm, 1/4-W. resistor;
- Two 500-ohm, 1 W. resistors;
- One 1,000-ohm, 1/2-W. resistor;
- One 2,000-ohm, 1/2-W. resistor;
- Three 25,000-ohm, 1/2-W. resistors;
- One 100,000-ohm, 1/2-W. resistor;
- One 10,000-ohm regeneration control;
- One 500,000 ohm volume control and A.C. switch;
- Five octal wafer sockets;
- Two 4-prong bakelite sockets;
- One closed-circuit jack;
- One power transformer;
- *One 5-in. dynamic speaker, 3,000-ohm field;
- One toggle switch;
- One double binding post assembly;
- Two small grid clips;
- One roll hookup wire;
- One line cord and plug;
- One hardware kit, consisting of:
 - 22 5/16 in. 6-32 machine screws and nuts
 - 5 large rubber grommets
 - 5 solder lugs;
- One Raytheon 6C5 tube;
- One Raytheon 6A4 tube;
- One Raytheon 6K7 tube;
- One Raytheon 6F6 tube;
- One Raytheon 5Z4 tube.

This article has been prepared from data supplied by courtesy of Allied Radio Corp.

COMPLETE HOME STUDY TRAINING FOR PROFESSIONAL SERVICEMEN

A complete, up-to-date course in Advanced Radio Service and Public Address Work, with or without Television. Terms as low as \$5 monthly. Start anytime—take up to 3 years to finish. Write for details now.

FREE!

Interesting illustrated booklet complete in details regarding your future and our courses. Mail a post card for your own copy today

RADIO SERVICE INSTITUTE

Subsidiary of CRST
Dept. RC-9, 3308 14th St., N.W., Wash., D. C.

HAVE YOU SOME SPARE ROOM

A basement or garage where you can do light work? We can offer you a profitable proposition casting 5 and 10c Novelties, Ashtrays, Toy Automobiles, etc. as Manufacturer for firm of many years standing. No experience necessary as we furnish full instructions with moulds. If interested in devoting your spare or full time to profitable work and you mean strictly business write AT ONCE for full details as we are now closing arrangements for supply of our goods.

METAL CAST PRODUCTS CO.
Dept. 26, 1696 Boston Road, New York, N. Y.

Vest Pocket Adding Machine

Sturdy Steel Construction. Lifetime Pocket Companion. Adds, Subtracts, Multiplies, Divides. Capacity, 999-999.99. A real machine—guaranteed 5 years. Send name and address. We ship immediately. On delivery, pay 50c man \$2.50 (plus few cents postage). (Foreign countries add cash.)

Free Trial \$2.50
Your money back after 10 days trial if not satisfied. Thousands of satisfied users. Send for Special Offer to agents.

TAVELLA SALES CO., 21 West Broadway, New York, N. Y.

ANTENNA COIL					
BAND	PR1	SEC	WINDING SPACE	SPACE BETWEEN PRI & SEC	
16-36 M	6 3/4 T	7 3/4 T	7/8"		
34-75 M	10 3/4 T	16 3/4 T	1"	1/8" ON ALL COILS	
73-130 M	17 3/4 T	31 3/4 T	1"		
108-217 M	18 3/4 T	56 3/4 T	1 1/8"		
OSCILLATOR COIL					
BAND	PRI	SEC	WINDING SPACE	SPACE BETWEEN PRI & SEC	
16-36 M	6 3/4 T	6 3/4 T	7/8"		
34-75 M	10 3/4 T	15 3/4 T	1"	1/8" ON ALL COILS	
73-130 M	17 3/4 T	26 3/4 T	1"		
108-217 M	18 3/4 T	40 3/4 T	1 1/8"		

ALL COILS ARE WOUND ON RIBBED LOW-LOSS BAKELITE FORMS 1 1/4" IN DIA. AND 2 1/4" LONG. NO 30 GA ENAM COPPER WIRE IS USED ON ALL WINDINGS

Fig. 2. Specifications for winding the coils.

Please Say That You Saw It in RADIO-CRAFT

THE "COLD CATHODE" GASEOUS RECTIFIER

(Continued from page 147)

Recently, however, further refinements of these ideas have been incorporated in the widely used 0Z4, the filamentless auto-radio rectifier tube.

The 0Z4 consists of 2 small graphite anodes, a small cathode made of ribbons of platinum coated with active barium or strontium oxides, all in an atmosphere of argon gas. Argon, which is known as one of the noble gases, is used to obtain low cathode drop, because it is chemically inactive and also because of its low breakdown voltage. Immediately surrounding each of the graphite anodes is a nickel cylinder which permits only the tips of the anodes to project. This shield prevents breakdown of the gas immediately around the anodes, thus preventing ionization from taking place which might in time destroy the anodes by bombardment.

THEORY OF GASEOUS-RECTIFIER OPERATION

The action taking place when such a tube is placed in operation in a vibrator-type power supply is that when about 300 V. appear across the elements, the gas ionizes, forming a large glow around the cathode and small ones on the tip of each anode. Vibrator-type power supplies with no-load, supply peak voltages of about 1,600 V., so that no trouble is encountered in ionizing the gas. Electrons shoot out of the cathode glow to the anode and positive ions of gas, that is positive atoms of gas, from which a few electrons have been knocked off, go towards the cathode. These positive ions are relatively

heavy having about 1,800 times the mass of the electrons. Since the cathode glow has a drop of about 150 V. the positive ions going from the glow to the cathode receive considerable acceleration and when enough of these fast-flying heavy ions strike the cathode sufficient heat is produced at the cathode to start the cathode emitting as a hot body. The further flow of current, providing it is above 30 ma. keeps the cathode heated and emitting. Under these conditions the tube drop becomes about 25 V. and remains surprisingly constant with increased drain. From this point on, the action of the tube is similar to the conventional mercury-type filament rectifiers with few of its difficulties.

The 0Z4 is not affected by temperature inasmuch as it uses argon gas which has a low temperature coefficient. Under some conditions a certain amount of electrical noise is sprayed from gas rectifier tubes of this type which can be taken care of by shielding. In the 0Z4G a small grounded metal cylinder around the tube is entirely sufficient, while the 0Z4 requires no additional shielding as the tube itself is surrounded by a metal can.

The low constant value of tube drop affords good regulation and efficiency and dissipates very little heat and power in the tube itself. The self-heating cathode does away with the usual difficulties encountered with filaments in auto-radio receivers.

This article has been prepared from data supplied by courtesy of Raytheon Production Corp.

THE "H"-PAD OFFERS CONSTANT IMPEDANCE TO THE POWER SOURCE

(Continued from page 147)

and opposite in phase, cancelling. Under this condition, the induced hum component disappears from the secondary voltage.

When long lines are run from the generating source to the input transformer, each half of the circuit should be balanced to ground to minimize hum pick-up. Lines can include a volume control and still be balanced to ground if an "H" pad is used as an attenuator. Figure 1C illustrates a circuit of this kind. The "H" pad illustrated includes 5 variable resistors that are simultaneously operated. This unit inserts the same resistance in each side of the line, therefore maintains line balance for any control position.

A control that includes 5 variable resistors is of necessity expensive and difficult to manufacture. By clever designing, an "H" pad is now available that incorporates only 3 variable and 4 fixed resistors. This new "H" pad accomplishes exactly the same purpose as the more expensive unit, that is, it offers constant impedance to the source, regardless of control setting and offers substantially straight line variation of attenuation with rotation.

Figure 1D illustrates the internal connections of this new "H" pad; it is shown pictorially, front and rear, in Fig. A. Each of the 4 fixed resistors has the same value and is equal to the nominal line impedance. The three variable resistors are tapered to offer straight line attenuation and constant impedance.

Figure 2 illustrates curves run with an actual production sample "H" pad designed to match a 50-ohm line. Note that the widest departure from the nominal impedance value of 50 ohms is about 16 per cent. This deviation is entirely within permissible limits. The attenuation is very nearly proportional to rotation at all points. At 5 per cent rotation, the attenuation is 45 db. At zero per cent rotation the attenuation is infinite; this means that the control cuts off all signal in this position. At 100 per cent rotation, the attenuation is zero. This control offers no insertion loss. The maximum safe power level is 1 W., many times the level met with in most mixing circuits.

The unit consists of 3 small graphite anodes, the flexibility with which it can be used. Any high-quality public address installation deserves the best of control equipment. The unit described finds many uses in this field.

This article has been prepared from data supplied by courtesy of Centralab.

HOW TO MAKE THE RADIO-CRAFT SUPER-DELUXE 30-TUBE SET

LIST OF PARTS

(Continued from page 136)

- Three RCA indicator-tube escutcheons, part No. 11276;
- Tinned-copper-braid sheathing, 1/2-in. dia., 10 ft.;
- Tinned No. 16 solid hookup wire (for filaments), 25 ft.;
- Shielded No. 16 hookup wire (for cables), 25 ft.;
- Hookup wire, No. 18 or 20, in several colors (for wiring other than filaments);
- One piece of sheet aluminum, 9 x 10 x 3/64-in. thick (for front panel template);
- One piece of half-hard aluminum, 23 x 3/4 x 1/16-in. thick (for indicator-tubes' brackets).

RADIO TRAPS DOGS!

Anton Tichy, Denver dog catcher, has a short-wave car-radio set tuned to police broadcast. When an irate housewife complains about a dog, Tichy arrives at the scene before the culprit can escape!

Please Say That You Saw It in RADIO-CRAFT

NOW READY

THE NEW SYLVANIA CHARACTERISTICS SHEET!



Let It Solve Your Tube Characteristics Problems!

No radio service man should be without this complete tube characteristics chart. It contains the very latest tube characteristics information available—information that can be found nowhere else.

COVERS MORE THAN 180 TYPES

The Sylvania Tube Characteristics Sheet suits service men to a "T." It covers more than 180 types . . . tube types are numerically listed . . . characteristics are tabulated . . . all characteristics and base diagrams are arranged on one side of the paper—*instantly available*. Also contains full information on the latest types of glass, metal and "G" tubes. Folds to pocket size—swell for your service kit!

Best of all, it's FREE! Just fill in the coupon below, and send it to us. You'll get your Characteristics Sheet . . . pronto!

SYLVANIA SET-TESTED RADIO TUBES

HYGRADE SYLVANIA CORP. RC-97
Emporium, Penna.

Please send me a FREE copy of the latest Sylvania Tube Characteristics Sheet.

Name

Address

City State

Dealer Service Man

Amateur Experimenter

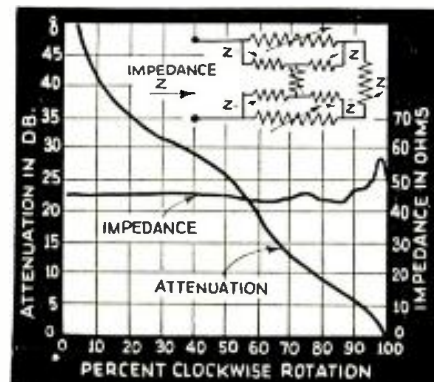

Fig. 2. Curves run with a 50-ohm line "H" pad.

ELECTRICAL BOOKS
shipped FREE
10 BIG BOOKS

Here's great news for anybody interested in Electricity. BRAND NEW edition of Applied Electricity brought right down to date with every NEW Electrical subject fully covered. 10 big Volumes and all shipped FREE for examination. See special offer below.

For **Beginners and Experts**
 Over 3000 pages—hundreds of illustrations—the most complete work of its kind ever published. Dynamos, motors, Power stations, radios, television, everything electrical explained clearly so anyone can understand them.

BIG FIELD! Big Demand! Big Pay! Men who understand electricity are urgently needed right now in thousands of industries. Autos, airplanes, machine shops—practically every industry depends on electricity and men who know this subject make big money. Pleasant, fascinating work, easy to learn and do. Send coupon for a set of these books for FREE examination.

FREE S. Gernsback's famous Radio Encyclopedia latest edition given free with these electrical books if you send NOW. Invaluable in any Radio work. Covers whole Radio field.

American Technical Society, Drexel at 58th St., Dept. E626, Chicago
 Send for 10 days' free use. BRAND NEW 10 volume set of Electrical Engineering. Include free membership in the American Technical Society and S. Gernsback's Encyclopedia. I will pay the few cents delivery charges on the books. If I wish I may keep them in 10 days and owe you nothing, but if I keep them I will send \$2.00 after 10 days, then \$4.00 a month until the special price of only \$29.80 is paid.

Name
 Address
 City State
 Attach letter stating age, occupation and name and address of employer, and at least one business man as reference.

FACTORY TO YOU
 NEW REMINGTON NOISELESS PORTABLE!



10¢ A DAY
 Famous Remington Noiseless Portable that speaks in a whisper, only 10c a day, direct from factory. Standard keyboard. Automatic ribbon reverse. Variable line spacer and all the conveniences of the finest portable ever built. PLUS the NOISELESS feature. Act now. Send coupon TODAY for details.

You don't RISK a Penny
 We send you Remington Noiseless Portable for 10 days' free trial. If not satisfied, send it back. We pay all shipping charges.

FREE Typing Course and Carrying Case
 You will receive FREE a complete simplified home course in Touch Typing. Also FREE a handsome, sturdy carrying case. No obligation. Mail coupon for full details—NOW

Remington Rand Inc., Dept. 139-9
 815 Fourth Ave., New York, N. Y.

Tell me, without obligation, how to get a new Remington Noiseless Portable, plus Free Typing Course and Carrying Case, for 10c a day. Send Catalogue.

Name
 Address
 City State

"HAM" SPECIAL Standard Teletex
 A highly efficient code teacher using heavy specially prepared waxed paper tape, having two rows of perforations. Write for Free folder A9. We are the originators of this type instrument
 Instrument with tapes prepared by expert and complete course all for \$11.95. Without Oscillator. 72-76 Cortlandt St., N. Y. C.

Learn SOUND RECORDING TALKING PICTURE PROJECTION TELEVISION-RADIO

Master training courses qualify you for good jobs. Practical, easy to learn. Newest equipment. Established 1905. Earn room and board while learning. Coach R. R. fare allowed to L. A. Write for FREE BOOK. Address Dept. 9-RC, 4000 S. Flamingo St.

NATIONAL SCHOOLS - Los Angeles

THE LATEST RADIO EQUIPMENT

(Continued from page 156)

minals as shown, is made in 5 different values in order to drop the voltage applied to the set, to match radio receiver current drains, to 2.1 V. and current drains between 480 to 720 ma.

NEW LINE OF P.A. UNITS CALIBRATED OUTPUT INDICATOR (1454)
 (Allied Radio Corp.)

ONE OF a series of new units in a line of matched P.A. amplifiers, merchandised under the trade name of Knight, is illustrated.

The systems include the following features: calibrated output indicator, streamlined cases, universal input, built-in mixer, metal tubes, and polarized plugs and receptacles. These sound systems are recommended for both permanent and mobile installations, and for 6 V., 110 V. and universal-current operation. Included in the new sound line are several inter-communication and centralized P.A. systems that have special appeal for department stores, institutions, hotels, schools, hospitals, etc.

UNIVERSAL-SERVICE ELECTRONIC FREQUENCY MODULATOR (1455)

THIS instrument, the model OA-5, with visual alignment electronically, operates with any oscillator or any size oscilloscope to simplify A.F.C. alignment and to provide an excellent method of locating intermittent trouble. It supplies synchronized horizontal sweep voltage for oscilloscopes.

It has calibrated sweep continuously variable from 5 to 40 kc.; and calibrated phasing control. Output is continuously variable from 1 microvolt to over 1 V. It gives direct-reading selectivity measurements.

The instrument has completely self-contained power supply. There are no rotating or vibrating parts.

5-IN. P.M. DYNAMIC FOR INTERPHONES (1456)

ILLUSTRATED here is an interphone and header-type of 2 new models of permanent-magnet dynamic loudspeakers utilizing high-coercive magnets of "nipermag"; the second model slightly larger in diameter, is designed for those applications where the 6-in. type of speaker is found to be too large. In addition to the nipermag field magnet, this new series of small speakers features a polyfibrous cone material and a dust-proof voice coil. The former provides an unusually wide frequency response range said to be unobtainable with other type cones; the advantage of the latter construction is quite well known to practising sound men.

PHOTOCELL AND GENERAL SERVICE AMPLIFIER (1457)
 (Wholesale Radio Service Co., Inc.)

RECOMMENDED uses of this amplifier include: low-power sound and music reinforcement, as for orchestras playing in small dance halls; pick-up system in hotels to "pipe" orchestral

music to lobby, private dining room, etc.; announcing system for the smaller bus or other transportation terminals, window demonstrations, telephone switchboard paging systems, restaurant kitchen calling systems, and industrial work of any kind that involves photoelectric control. The amplifier is particularly well-adapted to photoelectric burglar alarms.

Photoelectric cell input for industrial applications, such as counter, checker, door-opener, etc., is one of the many features included with a view to promoting universal application of this unit to amplifier requirements of every kind. Others involve mixer-fader input, tone control, Jewelled signal light, and speaker field power supply.

Two low-gain channels are provided for phonograph or radio reinforcement, and a single high-gain channel with enough amplification behind it to permit use of any modern microphone or of photocell as required. High- and low-gain inputs can be mixed and used simultaneously—thus, in a transportation terminal, for example, announcements can be superimposed on phonograph or radio entertainment.

IMPROVED P.M. DYNAMIC SPEAKERS (1470)

THE FIRST in a new line of 34 loudspeaker models is illustrated. Cone diameters range from 5 to 14 ins. The permanent magnets weigh from 5 to 46 ozs. Output capacities available up to 30 W.

A new type of molecular structure in the magnet is said to greatly lengthen magnetic life; over a period of years there is no audible decrease in speaker efficiency.

POWER SUPPLY FOR PIN-BALL MACHINES (1471)

VARIOUS models of these "rectopacs," as they are called, are available from the manufacturer, to furnish A.C. for lights, D.C. for kickers, relays and pay-outs of coin-operated machinery, and all other D.C. uses. They are furnished with 2 auxiliary terminals for connection to the switch or time clock so that current will be used only while the game is in operation. The same general type of D.C. supply may be used in high-quality amplifiers to supply filament current in order to reduce or even eliminate hum. Available D.C. output at 110 V. A.C. input, ranges (depending upon model) between 5 A. at 6 V. D.C. and 2 A. at 6 V. A.C., to 20 A. at 10 V. D.C. and 3 A. at 6 V. D.C. Dry-disc rectification is employed.

CLOSE-TOLERANCE MICA PADDING CONDENSERS (1472)
 (Aerovox Corp.)

DUE to the stability of the precise design—of this new adjustable mica padding condenser (which is used to replace the usual fixed condenser with trimmer in parallel) designed for use in I.F. and R.F. circuits, etc.—together with the micrometric adjustment, users can specify tolerances as close as plus or minus 1 per cent, states the manufacturer. Incorporates following features: finest grade mica; impreg-

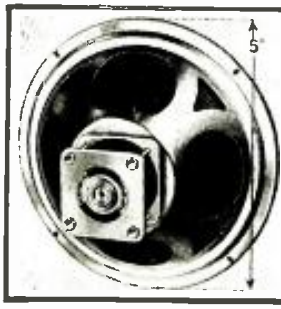

One of new line of P.M. dynamic speakers. (1470) Power supply for pin-game machines. (1471)

New series of close-tolerance mica padding condensers. A wide range of capacities is available. (1472)

Please Say That You Saw It in RADIO-CRAFT

nated to repel moisture; low-loss factor; negligible stray capacity; dual units with one terminal as common can be supplied, in somewhat less tolerances, in capacities up to 0.1-mf. for the combination.

RADIO SET KITS FOR THE BEGINNER (1473)

RADIO kit sets for the beginner have been designed that require practically no skill in putting together. The battery model is slightly less expensive than the A.C.-D.C. model. Both units cover the broadcast tuning range. Although these radio sets combine every requisite for a complete broadcast program receiver they are not "fancy"—but have been designed for sale at the lowest possible price; and are recommended for use in schools, etc., as an inexpensive means to demonstrate the basic principles of radio reception.

WORLD TIME CONVERTER SLIDE-SCALE (1474)

THE PURPOSE of the cardboard "gadget" illustrated is to provide a means of almost instantly converting the time and date of any one country to that of any other, or Greenwich Mean Time (G.M.T.) to local time the world over; and, of course, vice versa. It is not intended for use only in one particular time zone but in any country of the world where the user may be located. The converter is accompanied by a 12-page booklet and both fit into a handy container. This is almost an indispensable item for the Service Man and owners of short-wave receivers.

NEW P.A. AMPLIFIER HAS ELECTRONIC TONE CORRECTOR (1475)

A NEW 30-W. amplifier for public-address use features: (a) electronic tone corrector circuit—a dual-channel device with separate controls for both the high and bass ranges, affording unusually effective means for adjusting tonal balance; (b) unique preamplifier stage circuit to reduce hum.

Four-channel input for 2 microphones and 2 phono pickups, gain 12x db., frequency response 30 to 12,000 cycles, 30 W. undistorted output, 12 tubes including 2 beam-power tubes, 2 sockets for 2 plug-in speakers, universal input for velotron, velocity or crystal microphone, 105-125 V., 50-60 cycles A.C., consumption 175 W.

COIL KIT FOR EXTENDED RANGE SET (1476)

ILLUSTRATED here are the R.F. oscillator and I.F. coils for a complete receiver to cover the frequency range of 530 to 1,650 kc.; tuning

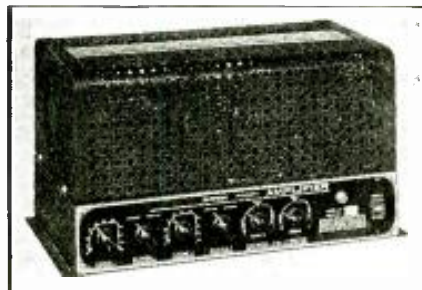

capacity 370 mmf. and pad capacity 535 mmf., with an I.F. of 262 kc. Designed primarily for 5-tube car-radio sets (less rectifier). Also available for household sets employing A.C. operation. The coils are of high-efficiency type including an iron-core antenna unit. This is coil combination No. 47.

NEW PHONO ATTACHMENT (1477)

THE FEATURE of this phonograph record-playing attachment is not alone the fact that it may be connected into the audio circuit of any radio set but that in addition it combines a beautiful piece of walnut furniture that adds its decorative bit to a room. The instrument that fits ideally beneath a midset radio set, on a table, or on top of a console radio. Simple to operate—the entire mechanism is attached to a slide panel which opens outward automatically to allow adjustment of record without removing the radio set. Other features include low capacity, shielded cord with phone tips for simple connection to radio set; volume control and speed control; modern self-starting sturdy motor; high-fidelity crystal pickup; special lever attachment to pickup to facilitate placement on records; latest 12-in. turntable, separate on-off switch. Size 17 x 15 x 9 ins. high; available in either A.C. or A.C.-D.C. models.

BUILD YOUR OWN VOLTAGE DIVIDERS (1478)

BY MEANS of handy sectional units and a mounting base of the required length to accommodate them, it now becomes possible to build or rather assemble one's own voltage divider to meet individual needs. Each sectional unit is a complete molded-seal metal-clad resistor, with 2 terminals, of the required resistance for that section. Bakelite-encased winding construction is used. Units slide into and fit snugly in the base mounting strip which takes the requisite number of units. Excellent conduction of heat from winding to mounting base, and metal mounting surface, provides for maximum watts ratings. Adjacent terminals are connected together to form a single resistance network to all the sections. Or the sections may be used individually since they are normally insulated from one another.

TRIPLE-TUNED I.F. TRANSFORMER (1479)

(Aladdin Radio Industries, Inc.)

ILLUSTRATED is a 3-section I.F. transformer to be used in the circuit shown in Fig. 1479A. The I.F. is 465 kc. An oscilloscope is not necessary for aligning; unit has a broad flat-top about 8 kc. wide; adjacent-channel rejection at 20 times down is about 30 kc. wide; the triple tuning condensers are adjusted from the top of the field. The type N200 unit is illustrated.

(Continued on page 182)

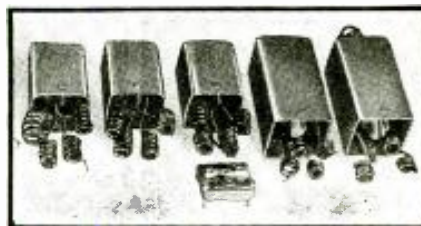

Above: High-efficiency superhet. coil kit. (1476)
Left: New P.A. amplifier featuring an "electronic tone corrector." (1475)

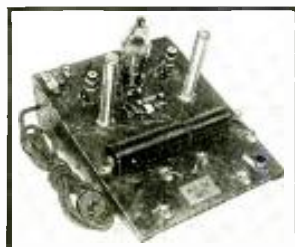
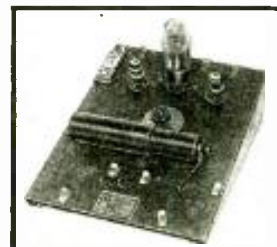

New battery model (left) and A.C.-D.C. model (right) simple radio set kits for the beginner. (1473)

A new time converter. (1474)

Please Say That You Saw It in RADIO-CRAFT

You Couldn't Get Better Performance in a SIGNAL GENERATOR If You Paid Twice the Price

MODEL 701
\$29.95



And that's no exaggeration — because the workmanship and design embodied in the new Model 701 Signal Generator are just about the last word in engineering. Attenuation from 1 microvolt to 1/2 volt through constant impedance ladder net work 5 steps. Sturdy construction; attractive, modern cabinet. Output for cathode ray modulation. Direct reading 4-1/2" dial. Multicolor frequency bands. From 125 kilocycles to 60 megacycles. Provision for external modulation. Automatic shorting of coils not in use to prevent influence of dead spots, etc. Electrostatically shielded power transformer. Separately shielded coil assembly, attenuator and R.F. circuits.

See your Jobber—
Write to Dept. C for Catalog

RADIO CITY PRODUCTS CO.
88 PARK PLACE NEW YORK CITY "DEPEND ON DEPENDABLE"

Aladdin
REG. U.S. PAT. OFF.

Midget I-f transformers for PORTABILITY



Extremely small size combined with extremely high performance. Polyiron gives high GAIN—high SELECTIVITY
ALADDIN quality in PERFORMANCE MATERIALS WORKMANSHIP

is exemplified in this miniature transformer in copper shield 1 1/2" sq. x 2 1/2" long.

- C 101m 465 kc. converter \$2.50 List
- C 100m 465 kc. interstage 2.50 List
- C 200m 465 kc. diode 2.50 List
- C 350 465 kc. H F O 2.50 List
- No. 504 Antenna Coupler (unshielded) 2.00 Lis.
- No. 20001 Oscillator Coil (shielded) 2.00 List

ALADDIN RADIO INDUSTRIES, INC.,
466c W. Superior Street, Chicago, Ill.

Licensee of Johnson Laboratories, Inc.

New! CATALOG OF AMPLIFIERS

All types, embodying latest principles of design and construction. Superior quality. Many new features and advantages. Superior values, remarkably low-priced. Used by leading P.A. Men. Write for free catalogue now! **AMPLITONE PRODUCTS CO., 135 Liberty St. N.Y.**

AMPLITONE

LEARN RADIO
the Easy way
with Ghirardi's Complete
RADIO PHYSICS COURSE
972 Pages \$4.50 8 Illus.
only 4.00

The world's greatest collection of radio knowledge in one huge 4 pound volume—Ghirardi's famous course used by thousands of students in 82 different countries. With this one book you can quickly master RADIO, ELECTRICITY and SOUND. Clear! Up-to-date! Complete! Inexpensive!

PARTIAL LIST OF SUBJECTS
Sound, Speech and Music, Electron Theory, Electric Current, Electrical Units, Ohm's Law, Batteries, Magnetism, Electromagnetism, Electromagnetic Induction, Inductance, Condensers, Alternating Current Circuits, Filters, Electrical Measuring Instruments, Electromagnetic Radiations, The Broadest Station, The Receiving Station, Vacuum Tubes, Radio Frequency Amplification, Superheterodyne Receivers, R.F. Amplifier and Coil Design, Audio Amplification, Loud Speakers, Battery Operated Receivers, Power Supply Units, Electric Receivers, Auto and Aircraft Receivers, Phonograph Pickups, P.A. Systems, Short-Wave Reception, Photoelectric Cells, Television, The Antenna and Ground, Testing and Servicing, Sound Motion Pictures, Appendices, 856 Review Questions for Self-Study.

Mail Now! Money-back Guarantee.

Radio & Technical Publishing Co.
45 Astor Place, New York, Dept. RC-97
 Encl. find \$4 for RADIO PHYSICS COURSE (Postpaid) (Foreign \$4.50)
 Please send free circular "1".

Name _____
Address _____

CRYSTAL HEAD PHONES
SOUND CELL MICROPHONES

Information on request
THE BRUSH DEVELOPMENT CO.
3312 PERKINS AVE - CLEVELAND, OHIO

PATENTS—TRADE MARKS
All cases submitted given personal attention by members of the firm.
Form "Evidence of Conception" and instructions
"How to Establish Your Rights"—Free
LANCASTER, ALLWINE & ROMMEL
PATENT LAW OFFICES
436 Bowen Bldg. Washington, D. C.

RADIO COURSES
RADIO OPERATING: Prepare for Gov't License Exam. ● RADIO SERVICING: Including Short Wave ● AMATEUR CODE ● ELECTRONICS ● TELEVISION ●
Day and Evening Classes—Booklet Upon Request
New York YMCA Schools
4 W. 64th Street, New York City

On broadcast as well as shortwave frequencies, in any location, you can eliminate "man-made" static with
NOISE MASTER
ALL-WAVE ANTENNA
Send for complete literature
CORNISH WIRE CO., 30 CHURCH STREET, NEW YORK CITY

(Continued on page 181)

IMPROVED RESISTORS (1480)

IMPROVEMENTS in one make of resistor are identified numerically in the illustration. (1) Unusually even windings prevent "hot spots" and resulting failures; (2) a specially developed vitreous enamel not only holds the wire in place but also forms an excellent heat conductor; (3) a porcelain core is used; (4) has tin-dipped copper terminals to facilitate soldering; the resistance wire is both brazed and mechanically locked to the terminals; (5) mounting brackets are easily demounted; (6) resistance value is identified on aluminum band.

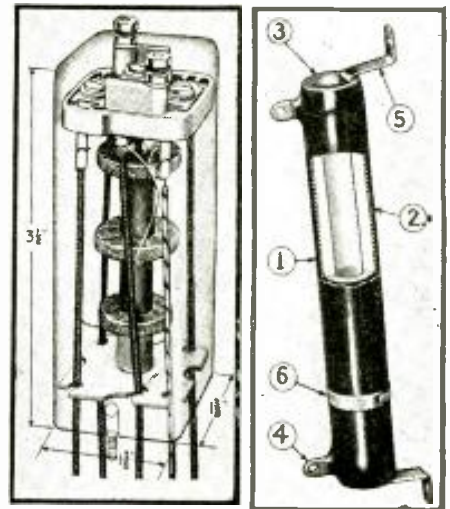

New 3-winding I.F. transformer, 465 kc. (1479) Improved resistor prevents "hot spot." (1480)

OFFSET SCREWDRIVERS (1481)

THE AVAILABILITY of a screwdriver that will reach otherwise inaccessible places in many cases will pay for itself, in time saved, on a single job. They are available, as illustrated, in 2 sizes, 4 1/2 x 1/4-in. and 8 x 3/8-in. They are made of fine tool steel and really hold their edges.

A RADIO GIMBAL (1482)

(William A. Thomas Co.)

A GIMBAL, states the dictionary, is a mounting that permits motion in both azimuth and zenith. As here shown it is designed to mount a radio set or power amplifier, permitting top, underside and left- or right-side examination, as well as inspection of any intermediate arrangements. States the manufacturer, "permits lightning-speed adjustments for any size chassis within its capacity from the smallest size up to and including 13 x 21 ins. long." Specially designed brakes securely hold the chassis, regardless of whether chassis has rolled-over or straight sides.

Not only a time-saver for the Service Man but also excellent for displaying construction features in radio sets of advanced design; and for lecture purposes. A radio receiver in this mounting rolls in all positions like a marine compass in its bearings.

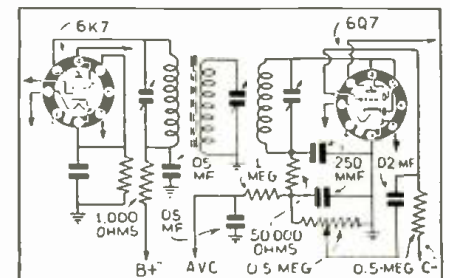

Fig. 1479A. The new 3-winding I.F. transformer in use in a typical circuit. (1479)

ORNAMENTAL AUTO-TOP ANTENNA (1483)

CONSIDERABLE effective area is available in the arrow-like car-radio antenna illustrated. This antenna mounts by means of rubber suction cups. Placing the aerial in the position shown and properly shielding its lead-in reduces interference from the ignition system and eliminates wheel static—as compared to antennas less remote from these sources of interference.

USEFUL RADIO CONSTRUCTION DATA BOOK AND CATALOG

Out of a total of 112 pages, the new Meissner catalog and technical data book devotes 80 pages to complete constructional data on more than 15 receivers of various designs. The data include schematic and wiring diagrams, instructions, coil information and chassis layouts. The book may be obtained from Meissner Mfg. Co. for the price of 50c.

NEW A.C.-D.C. PATENT GRANTED

Patent No. 2,086,256 granted July 6, 1937 to H. G. Cisin is claimed to give him valid royalty claims on all A.C.-D.C. sets being manufactured commercially. Many of Mr. Cisin's technical articles have appeared in *Radio-Craft*.

NEW BOOKLET

Service Men will find this handy, pocket-size booklet, "Radio Interference Elimination," of great assistance. It treats of radio interference from all imaginable sources. Available from Continental Carbon Co., Inc.



Sectional resistor units permit "building" of one's own voltage dividers. (1478)

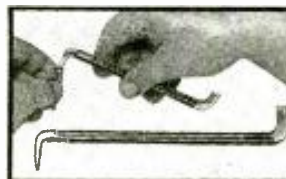

Two sizes of offset screwdrivers permit easy access to all screws. (1481)



New phono attachment for mid-gest sets. (1477)

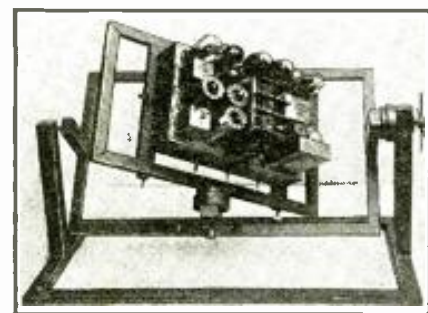

New gimbal for orientating radio chassis. (1482)

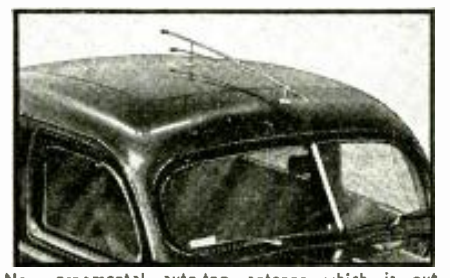

New ornamental auto-top antenna which is out of the "noise field" of the ignition. (1483)

Please Say That You Saw It in RADIO-CRAFT

THE LATEST RADIO EQUIPMENT

(Continued from page 157)

NEW LINE OF IRON-CORE TRANSFORMERS (1464)

(Hammarlund Mfg. Company)

FIRST in a line of iron-core transformers is a group of 465 kc. I.F. units.

Especially developed, finely-powdered and high-permeability magnesium alloy is used for the core. This alloy is rust-proof and non-corrosive. This type of core affords high inductance with minimum number of turns. The gain of these transformers is so high that a single stage using them will usually provide sensitivity and selectivity equivalent to 2 stages employing air-core transformers; an added advantage is the reduction in the tube noise.

DYNAMIC MICROPHONE HAS MANY FEATURES (1465)

(Universal Microphone Co.)

FACTORY specifications on this new dynamic microphone are as follows: frequency response 40 to 8,000 cycles; available impedances: high impedance direct to grid, and in 33 ohms, 50, 200 and 500. The instrument is self-energizing, is unaffected by heat or moisture, and has no hum pick-up—the transformer utilizes double, hum-bucking coils on a self-shielding square core. The output of this microphone is -5 db.; the unit may be used with an amplifier having a gain of 80 db. or more. Note that the volume control is built right onto the microphone. The convenience of this arrangement in many uses is immediately apparent.

WIND CHARGER FOR LOW-WIND-VELOCITY AREAS (1466)

A WIND CHARGER designed to maintain its charging rate at a wind velocity beginning at only 4 miles per hour has recently been developed. As with previous types of wind chargers this unit in conjunction with a 6 V. storage battery affords the innumerable services available from a 6-V. storage battery. Among the features of this charger are its air-foil propeller of Douglas fir, 8 ft. in length and equipped with steel leading edges; and a governor consisting of a 5-ft. propeller mounted, on a variable-pitch hub energized by flyball weights, at right-angles to the main propeller. Generator is equipped with grease seal ball-bearings and built-in radio noise suppressor.

ALL-PURPOSE RADIO SET (1467)

THE CHARACTERISTICS of this new 6-tube superhet. immediately identify it to the technician as a most versatile instrument. It features a battery drain less than 3 A., and is known as the Motorola Companion. A 6 V. battery and 110 V. plug-in portable set, it can be used as a trailer radio and on outings, as well as in the home as an auxiliary set.

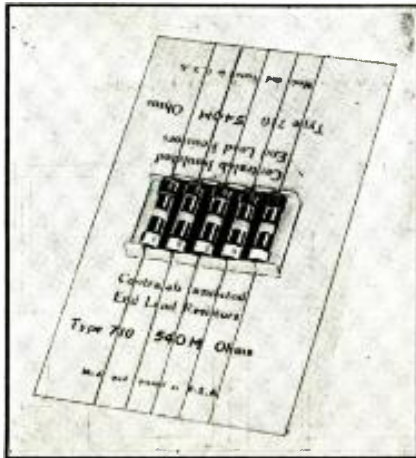

New resistor; pkg. of 5 is shown. (1485)

NEW "PORTABLE POWER" UNIT (1468)

THIS power supply unit, which operates from a 6-V. storage battery, is recommended for automobile P.A. systems; portable, mobile and marine transmitters; radio receivers, etc. This "vibrapak" weighs 5½ lbs.

These "vibrapacks" are available in both synchronous and rectifying types, and in interrupter- or tube-rectifying models; the latter being required only when "B-" cannot be at ground potential. The vibrators used in these units are of long-life type especially designed for this particular application.

COMPLETE SERVICING TEST-KIT (1469)

(Weston Electrical Instrument Corp.)

SERVICING MEN now have available in a single portable case a complete servicing set—carrying the trade name of Servicet—comprising a 20,000 ohms/volt analyzer and a tube tester. Although electrically independent the 2 instruments form a balanced operating unit in function and design that permits servicing the most critical of modern radio receivers.

The 2 matched-unit servicing instruments whether used in workshop panel mounting or as portable instruments feature exceptional sensitivity, flexibility and operating range as individual units; and offer these advantages plus unified appearance and balanced operation as a dual combination. The carrying case of the portable set-up shows what can be accomplished in obtaining compactness in test equipment—the case measures only 14 x 17 x 5¼ ins. deep. Both units are designed around obsolescence-proof circuits.

OUTPUT AND VOLT-OHM-MILLIAMMETER (1484)

A LARGE 3-in. meter and 2-color dial are used in this instrument. Ranges: 0/1/10/250 ma. D.C.; 0/10/250/1,000 V. D.C. at 1,000 ohms-volt; 10-ohm ½ to 500 ohms and hi-ohm 200 ohms to 0.5-meg. Bakelite case measures 3¼ x 2¾ x 6½ ins. high.

COMPLETELY INSULATED END-LEAD RESISTORS (1485)

(Centralab)

THIS NEW line of resistors may be overloaded about 5 times! Contact is made to the active resistor element at the extreme ends in order to utilize the entire length of the resistor. The increased length and reduced diameter of the conducting material increases the radiation area and reduces the specific resistance; this results in low-noise level, and constant value over a wide range of frequency and voltage. A ceramic jacket that surrounds the conducting core provides a seal against humidity.



(1484)
A new combined output meter and volt-ohm-milliammeter for the Service Man. Uses 1,000 ohms-volt meter. Measures up to 1,000 V., D.C. and 250 ma. Lo-ohm scale 0.5- to 500 ohms. Hi-ohm scale 200 to 0.5-meg.

Please Say That You Saw It in RADIO-CRAFT



Chicardi's LIGHTNING TROUBLE SHOOTERS

Spot Troubles—Give Tests and Remedies—INSTANTLY The World's greatest time-saving inventions for radio service men. They list all possible trouble sources. They tell you exactly what tests to make—what remedies to use. You'll be amazed to see how much these gadgets tell, how easy to use. A flip of a card may save you hours of tedious work. Cost pennies—earn dollars!

FOR HOME RADIOS—Complete trouble-shooting for 9 common symptoms—Hum, Weak, Noisy, "Dead," Intermittent Reception, Fading, Oscillation, Distortion and Rattling.

FOR AUTO RADIOS—Complete trouble-shooting for 11 common symptoms—Hum, "Dead," Weak, Noisy with both car and engine at rest; Noisy when car is at rest with engine "idling"; Noisy when car is driven normally; Noisy when car is "coasting" with ignition off; Intermittent Reception; Fading, Distortion, Oscillation.

Keep 'em in your pocket—take 'em with you on all jobs!

Speed Up—MAIL TODAY 50¢ EACH

Radio & Technical Publ. Co., Dept. RC-97
45 Astor Place, New York, N. Y.
Enclosed find \$..... for..... Gadgets.
 HOME-RADIO GADGET. AUTO-RADIO GADGET. (Foreign 60¢ each)
Name.....
Address.....
5-DAY MONEY BACK GUARANTEE!

Doing a world-wide job....

little giant

SOLAR

COMPACT Dry Electrolytic CAPACITORS

So small... efficient... completely equaling standard sizes in dependability! All usual capacities; two ratings, 450 v.w. and 280 v.w. You won't believe your eyes!

SOLAR MFG. CORP.
599-601 Broadway, New York, N. Y.

Descriptive literature upon request

DON'T! BUY ANY AMPLIFIER OR PUBLIC ADDRESS SYSTEM

until you read our bulletin describing a new line of 1938 advanced amplifiers designed by A. C. Shaney with such revolutionary features as:
Cathode-Drive Amplification
Automatic Feedback Suppression
F. V. F. B. Beam Power Amplification
Automatic Audio Volume Control
Floating Audio Power
Automatic Volume Expansion
Plus many other exclusive features.

Our Amazingly Low Prices. FREE TRIAL OFFER, and Usual FIVE YEAR GUARANTEE Make It Well Worth Your While to Write To-Day for Free Bulletin No. PA 947. Free P.A. Consulting Service.

AMPLIFIER CO. of AMERICA
37 West 20th St., New York, N. Y.

This SCREWDRIVER Actually GOES AROUND a CORNER!

Greatest Screwdriver Ever Made!



USE this FLEXIBLE SHAFT SCREWDRIVER — the screwdriver that actually goes around a corner—in your service work. It reaches many awkward places where a straight or offset driver. Has a thousand and one uses—ideal for repairing radios, refrigerators, automobiles, oil burners, machinery, shop equipment, electrical appliances, vacuum cleaners, marine equipment, household jobs, etc. The FLEXIBLE SHAFT SCREWDRIVER has a shaft of laminated steel wire—tempered steel blade—chromium-plated fittings—fluted, hard-wooden handle—length overall 8". PRICE, **\$1.00** POSTPAID

FLEXIBLE DRIVE SOCKET SET

The most practical socket set ever developed for radio work—ideal for "hard-to-get-at-places." Set consists of 10" Flexible Drive with six (6) removable sockets having hex openings in the following sizes:

3/16" 1/4" 5/16" 3/8" 7/16" 1/2"

The FLEXIBLE DRIVE SOCKET SET is similar in construction to the screwdriver. With each socket set is included a FREE, steel carrying case. PRICE **\$3.00** POSTPAID



COMBINATION SET SCREWDRIVER SOCKET SET \$3.50

GRENPARK COMPANY
1229 Park Row Bldg., New York, N. Y.

RC-97
1229 PARK ROW BLDG., New York, N. Y.

Gentlemen: Enclosed you will find my remittance of \$.....for which please send me, POSTPAID, the equipment indicated by the cross (X) below:

() FLEXIBLE SHAFT SCREWDRIVER @ \$1.00
() FLEXIBLE DRIVE SOCKET SET @ \$3.00
() COMBINATION SET (Screwdriver and Socket Set) @ \$3.50

Name

Address

City State

BETTER CONDENSERS
mean . . .
MORE PROFITABLE SERVICING



Cornell-Dubilier type JR etched foil dry electrolytics are the ideal condensers for tough servicing jobs during warm weather. Triply sealed, these capacitors are amply protected against abnormal temperature and humidity conditions. Supplied in handsome silvered containers with sturdy mounting feet and convenient terminal leads. Complete details in Catalog No. 137A.

CORNELL-DUBILIER CORP.
SOUTH PLAINFIELD, NEW JERSEY

MODERNIZE YOUR OBSOLETE TUBE CHECKER OR SET ANALYZER with "PRECISION"

Write for details. Mention make and model number of your old instrument.

PRECISION APPARATUS CORP.
821 EAST NEW YORK AVE, BROOKLYN, N. Y.

APPLICATION OF FEEDBACK TO A BEAM POWER AMPLIFIER

(Continued from page 151)

The reduction in sensitivity is not an important factor, as the 6L6 in common with other beam power tubes, has a very high amplification factor. The elimination of distortion, however, is an important one.

Figure 3 illustrates a curve (based upon Hygrade Sylvania data) showing the relative percentage distortion versus power output of a single 6L6 tube with and without feedback. The same ratio of distortion reduction is effected when using push-pull tubes.

REDUCED PLATE RESISTANCE

The 6L6 tube, while a tetrode, has the common failing of pentodes and other high-power-sensitivity tubes in the fact that the dynamic plate resistance is quite high. In normal operation, the 6L6 plate resistance is 22,500 ohms. High plate resistance becomes an important factor where a tube is used with a load of varying impedance. Mr. Otto Schade of RCA recently analyzed a condition of this type where the load was that of a loudspeaker.

In Fig. 4 we illustrate the effective circuit of a speaker coupled to an output tube. It is apparent from the figure that the voltage developed in the tube circuit is distributed between load resistance r , and the dynamic plate resistance R . If the plate-to-plate resistance of the tube circuit is 45,000 ohms and the reflected load at 1,000 cycles is 6,600 ohms, the actual voltage developed across the speaker system is 0.13 of the total voltage.

However, at the point of resonance of the speaker system, the reflected speaker load increases to about 66,000 ohms. At this point, 0.6 of the total voltage is developed across the reproducer. It is apparent that a considerable increase in power to the speaker is obtained.

The combination of this increase in power plus the original resonance of the loudspeaker

will naturally result in a very strong and frequently objectionable boom. This is a condition which is frequently encountered in console radio sets using pentode output tubes. In some cases, this cumulative output effect at a low frequency may cause rapid speaker failure. If an analysis is made of the same condition it is found that the plate resistance is reduced to approximately 7,000 ohms. Under this condition, at 1,000 cycles, the portion of the total voltage developed across the speaker is 0.5. At the resonance frequency this ratio is 0.9. The difference between 0.5 and 0.9 is of course much less than that encountered in the circuit not using feedback.

6L6 TUBES AS DRIVERS

A similar condition to the above is encountered where a tube is used as a driver for a class AB or class B amplifier. At maximum power output, the grid impedance of such tubes is very low. The greatest power transfer will therefore occur only if the resistance of the driver circuit is low.

In other words, if the reflected impedance of the output grid circuit at maximum swing were 1,000 ohms, and the driver tube source impedance were 45,000 ohms, approximately 1/46 of the effective voltage would be delivered to the grid circuit. However, using feedback, the driver impedance can be reduced to 7,000 ohms under which condition approximately 1/2 of the voltage would be delivered to the output grid circuit.

The increase in efficiency is very great. In the UTC fixed-bias PAK kits, the high plate resistance of the low power triode driver tubes is reduced in the same way permitting considerable driving power to be obtained from a relatively low power tube. Where high driving power and efficiency is required, the 2A3 tube is superior to the 6L6 tube because even though the power output of the 2A3 tube is less, it has a much lower plate resistance than the 6L6 tube.

POWER OUTPUT

Using the 6L6 tubes in self-bias with stabilized feedback, a power output of 35 W. is readily obtainable. This same amplifier can be modified for fixed-bias service by removing the cathode resistor and placing a 22 1/2 V. "C" battery between the grid-return lead of the 6L6 tubes and ground. Under this condition of operation, considerably greater output power is required from the driver tubes. The circuit shown in Fig. 5 is used in this case to reduce the effective plate resistance and increase the power output of the 6C5 drivers. Under this condition of operation a power output of 55 W. can be obtained from the pair of 6L6 tubes.

CIRCUIT DETAILS

Another interesting feature in this amplifier is the use of a dual mixer input with electronic

(Continued on page 187)

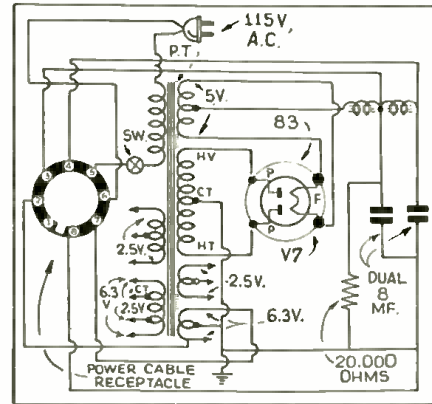

Fig. 2. Schematic of the power supply.

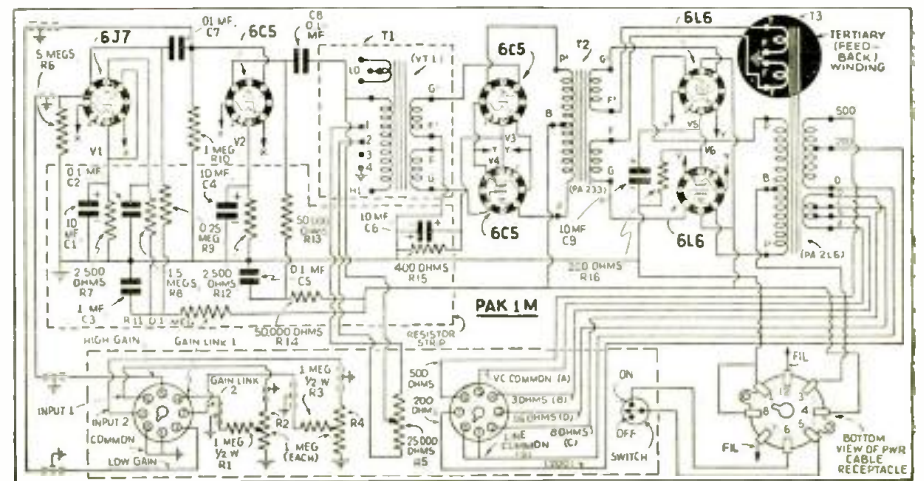
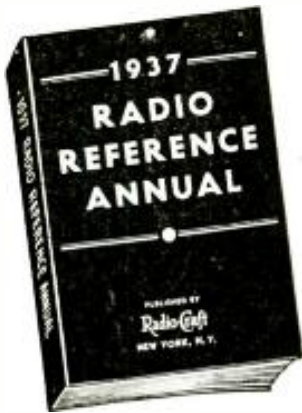

Fig. 1. Schematic circuit of the beam power amplifier showing (in circle) the feedback winding.

Please Say That You Saw It in RADIO-CRAFT

GET THIS *new* FREE BOOK!

Every Radio Man Can Use
to Advantage!



THE Editors of RADIO-CRAFT have prepared a special book for you. The new book—1937 RADIO REFERENCE ANNUAL—is not for sale, but available only to subscribers, both new and old, with a Seven Months' Subscription to RADIO-CRAFT. The price of this Special Offer is only One Dollar (\$1.00)—and as an additional saving the book is mailed to you postpaid as well as is the magazine each month. Carefully outlined below is the contents of this new book; it contains information which every radio man needs. The book contains 64 pages, size 6 x 9, and is replete with illustrations.

Read these Interesting Chapter Headings of
1937 RADIO REFERENCE ANNUAL

Receiver Construction

Building a 12-tube All-Wave DX receiver—How to make a modern 6 tube Car Radio set—building up a 2 tube Beginner's Set, with several different power supplies for various uses—constructing a 2 tube budget set for portable use—How to build a "talking" briefcase—no aerial or ground needed.

Test Equipment—Construction

How to make an "Electronic Eye" output meter—How to construct an ultra compact universal Volt-Ohm Milliammeter—How to make a Resistance-Capacity tester—How to Build a Pocket Adapter for set testing—Building a Portable Capacity bridge—Construction of a V.T. Voltmeter in compact form—How to Make a Modern Set Analyzer.

Audio and P. A. Equipment

Making an Audio Bass Booster, using direct coupling—How to build and add a Dual-Channel Amplifier to your receiver—Constructing a High-Fidelity Amplifier—Construction of a 3-tube A.C. operated Amplifier. Fundamentals of "The Bel Level" and "Decibel Gain."

Articles for the Service Man

Servicing with the Oscilloscope—Servicing with a Single Meter—"What's Wrong With Your Radio"—Share—Tapers of Volume Controls—and use of various types—Ideas for the Service Shop—Aligning All-Wave Receivers.

Time and Money-Saving Kinks

In this section you profit by the experience of other radio men. These kinks are really valuable "short-cuts" which save much time and, very often, money. They are "pet" jobs put into practice.

**Important Articles Which Have Appeared in
RADIO-CRAFT**

General Interest Articles

Design of Transformers for Class "AM" and "B" operation—A table of Inter-Electrode Capacities for 30 different tube types—How to make a Floating-Grid Relay—Construction of a modern Treasure Locator—How to get DX on your All-Wave Radio—Making a 5 meter Transceiver for use in car or boat.

New Tubes Developed in 1936

Characteristics of the Newest Receiving Tubes of all manufacturers, giving uses, characteristics, present equivalents (if any) and all pertinent data.

RADIO-CRAFT

99 Hudson Street New York, N. Y.

RADIO-CRAFT, 99 Hudson St., New York, N. Y.

Gentlemen: Enclosed you will find my remittance of One Dollar (\$1.00) for which enter my subscription to RADIO-CRAFT Magazine for Seven Months. Send me ABSOLUTELY FREE, and POSTPAID, my copy of 1937 RADIO REFERENCE ANNUAL.

Name

Address

City State

(Send remittance by check or money order. Register your letter if you send cash or unused U. S. Postage Stamps.)

RC-037

A SELECTIVE POCKET-SIZE CRYSTAL SET FOR BEGINNERS

(Continued from page 139)

(or the electrical noise which it produces) can be heard in the headphones then that particular spot on the crystal is suitable for receiving radio signals. Otherwise reset the "catwhisker" and make the buzzer test over again. If a buzzer is not available then it is a matter of trial and error. Move the wire over the crystal surface until a spot is reached that will detect the incoming signals.

This little crystal set was first tested in a modern steel building in New York City with a 20-ft. wire dangling from a window as an aerial. The results were remarkable, considering the circumstances. Five different stations were tuned-in with comfortable earphone volume. Several others were also tuned-in, but faintly. With a decent outdoor aerial they would have been much louder.

If upon completing the set you fail to receive any stations, try the following remedies:

- (1) Check the wiring against the diagrams for possible errors;
- (2) Clean the crystal detector by wiping the surface with a cloth dipped in ether or carbon tetrachloride ("cleaning fluid");
- (3) File the very tip of the "catwhisker", or snip it with pliers, to a very fine point to assure good contact;
- (4) Try resetting the "catwhisker" on various points of the crystal surface in order to find the most sensitive spot;
- (5) Check the aerial and ground connections and the aerial itself;
- (6) Try several other pieces of galena—usually there is wide variation in sensitivity;
- (7) Make sure the headphones are really sensitive—sometimes the pole-pieces are so far from the diaphragm, or the magnets are so weak, that the phones are no longer sensitive to weak signals, although they may be quite satisfactory for strong signals.

RADIO AND P.A. FOR TOURING CYCLISTS

(Continued from page 138)

both powered by a storage battery inside the sidecar, were suggested in the views partly for convenience in illustrating the idea. However such a set-up is quite adequate for the average needs of a bicycle brigade. On the other hand the fan who wants to have a somewhat more reliable combination for frequent use will do well to substitute for the glass heater-type tubes the more sturdy, lower-draw metal types now available. Also a simple superhet. or T.R.F. tuner may be combined with the audio power amplifier in one chassis. A real swanky touch could be added by using remote control of the tuning and volume such as employed in the operation of car-radio sets.

A 1- to 5-W. amplifier probably will be suitable for all the average needs in bicycle use. It probably will be necessary to utilize a 10-W. or sometimes even a 30-W. amplifier for motorcyclists.

There is considerable difference in the 2 types of operation and whereas even dry cells and "B" batteries could be used in limited bicycle operation a storage battery and heavy-duty vibrator or motor-generator "B" supply would be essential for practical work in motorcycle service.

Another difference lies in the sound projector systems. Whereas in the first instance an ordinary dynamic reproducer mounted on a baffle would afford excellent coverage, a trumpet or at least a directional baffle almost certainly would be demanded in motorcycle use in order to provide adequate sound level at the more distant rear points.

In October Radio-Craft!

A new radio device that instantly indicates whether a singer or instrumentalist is off-key. It indicates an off-key note long before the most expert ear can detect a change.

Please Say That You Saw It in RADIO-CRAFT

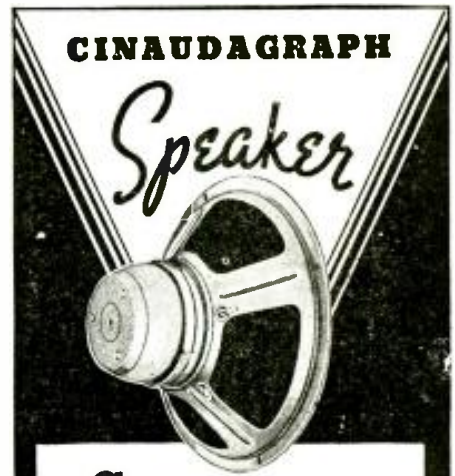

CINAUDAGRAPH Magic Magnet Speakers

—extensively utilized by all leading radio receiver and P. A. equipment manufacturers—are available in a complete range of sizes from 5½ to 18 inches. to meet your every radior requirement.

If you demand utmost dependability and fidelity of reproduction from your equipment—in-ist on Cinaudagraph P. M. speakers. Carried in stock by all progressive distributors. Free descriptive literature on request.



**CINAUDAGRAPH
CORPORATION**
Speaker Division • Stamford, Conn.



FREE!

HAMMARLUND 25th YEAR RADIO CATALOG

The most complete catalog ever published with special illustrations, drawings, curves and a complete description of the famous 16 tube "Super-Pro." Write Dept. RC-9-37.

HAMMARLUND MFG. CO., INC.
424-438 West 33rd Street, New York



UNIVERSAL Velocity Microphone

- 100% PERFORMANCE
- 100% APPEARANCE
- 100% SATISFACTION
- OR 100% REFUND

Made in following Impedances
33 ohms. for dynamic mike lines
200 ohms. to connect to carbon mike inputs
500 ohms. for telephone and remote lines

10,000 ohms. high impedance direct to grid
Not affected by heat, cold or moisture.
Jobbers—Write for refund guarantee plan that will double your sales and satisfy every customer.

MICROPHONE DIVISION

UNIVERSAL MICROPHONE CO., LTD.

424 Warren Lane Inglewood, Cal., U. S. A.

LES Correspondence Courses in
RADIO and ELECTRICAL ENGINEERING

ELECTRICAL ENGINEERING Get good grasp of wide electrical field. Prepare yourself, at Low Cost, for secure future. Modern, simplified, you can understand quickly.

RADIO ENGINEERING Extra fine course in radio, public address, etc. He address, photo-electric work, technician. Exper. kits furnished. Diploma on completion. Tuition: \$25. Get copies of school catalogs, student magazines, complete details. **SEND NOW!**

FREE

LINCOLN ENGINEERING SCHOOL, Box 831-39, LINCOLN, NEBR.

G.E. PHONOGRAPH MOTOR

Formerly Sold for \$15.00



Only \$4.95

VARIABLE speed induction type self-starting, 110 volt, 25 to 60 cycle, AC, with speed control. Plug and cord. Speed range from 5 to 200 R.P.M. Can be installed in place of old fashioned, hand-winding speed motor. Also ideal for display turn table, and a hundred other uses. These General Electric Motors are brand new, in original factory cartons. **\$4.95** G.E. Electric Phonograph motor as described. Shipping Weight—12 lbs.

WESTINGHOUSE UNIVERSAL MOTOR

\$2.95 110 Volts AC and DC



Shipping Weight 3 lbs.

THESE Motors are manufactured by the Westinghouse Electric Co. They are absolutely new. Specifications: 1/30 H.P., operates on either A.C. or D.C., 110 volts, 5000 R.P.M. Rheostat can be used to vary speed. Height 3 1/2", Length 3 3/4", Width 1 1/4", Shaft 1/8" one inch long. Can be used to drive Sewing Machines, Models, Buffing Lathes, Polishing Head, Drills, Grindstones, etc., etc.

MOTOR only **\$2.95**
 MOTOR with Arbor and 1/4" Chuck **\$3.95**
 Add 25c for special packing and mailing anywhere in U. S. A.

MICROPHONE AND RECEIVER

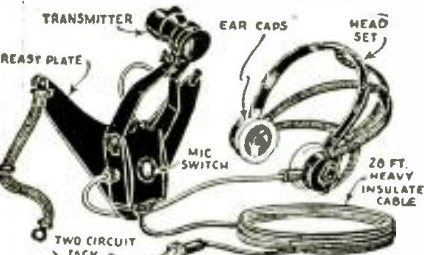

TRANSMITTER, EAR CAPS, HEAD SET, BREAST PLATE, MIC SWITCH, 20 FT. HEAVY INSULATED CABLE, TWO CIRCUIT JACK

THIS Microphone and telephone headset outfit was built especially for the U. S. Navy Aviation Corps. The Hultz-Cabot Electric Company constructed the outfit to Government specifications. The outfit consists of a low-impedance carbon microphone (transmitter), securely fastened to a metal breast-plate, and a set of heavy-duty, low-impedance earphones. A specially constructed switch on the back of the breast-plate controls the microphone circuit. The earphones are U.S.N. 114h type, attached to adjustable headband. Twenty eight feet of very heavy weather and waterproof conductor cable is furnished. Current of not more than 10 volts should be used. A storage battery is the most satisfactory current supply. **\$4.95** U. S. Navy Airplane-type Microphone and Receiver as described. The shipping weight is 9 lbs.

WESTINGHOUSE POWER GENERATOR

Manufactured for U. S. Signal Corps
 A.C. Electrical 200 Watt 110 V. AC Power



from a Windmill, from available Waterpower, from your Automobile, from your Motorcycle, from your Bicycle, Foot-pedals or Handcrank for transportable Radio Transmitters, for a Floodlight, for lighting Signs; do you want to operate AC Radio sets from 22 V. DC from light systems; operate 100 generators in series to get 200 V. AC; obtain two phase and three phase AC, etc., etc. 1 1/2 H.P. needed to run generator.

There Are Over 25 Applications, such as: A.C. Dynamo light from eight to ten 20 Watt 110 Volt lamps, Short Wave Transmitter supplying 110 Volts A.C. for operating "Ham" transmitter, Operating 110 V. AC 60 Cycle Radio Receiver in DC districts, Motor Generator, Public Address Systems, Electric Streets on motor boats, yachts, etc. Camp Lighting, etc., etc.

Blue-Print 22 x 28 in. and Four-Page 8 1/2 x 12 in. Instruction Sheets, Generator, as described including four replacement carbon brushes. Shipping weight 18 lbs. **\$7.90**

All merchandise in original packages—never used. Money-back guarantee.

We will forward Shipments by Express Collect if sufficient postage is not included.

WELLWORTH TRADING CO.

560 W. Washington Blvd., Dept. RC-937, Chicago, Ill.

"BUTTON TUNING" IS THE NEWEST CONVENIENCE

(Continued from page 138)

foreign stations are marked by name on the dial. The same arrangement holds true for the 49-, 39- and 19-meter bands.

Another development, Magic Voice tone quality, which attracted a great deal of attention last year, has this year been brought to an even higher state of perfection. The space immediately surrounding the loudspeaker unit has been scientifically sealed in a chamber shaped like an arc. The back waves from the speaker are thus controlled, directed and released through a number of measured openings to blend with the sound coming out of the front of the set and create a truly "natural tone" quality. This new "Sonic-Arc Magic Voice" eliminates the boominess and overemphasis of the low tones found in many other receivers.

Added to all of these new developments are innumerable other features, such as the Magic Brain and Magic Eye, which with almost human intelligence direct and control the functions of the radio set.

This article has been prepared from data supplied by courtesy of RCA Manufacturing Co., Inc., RCA Victor Division.

READERS' DEPARTMENT

(Continued from page 174)

For picking up the sound vibrations from a guitar, etc., remove the cap from the phone and place the diaphragm directly on the wood vibrating surface. One earphone will do very well. The leads from the earphone go to the amplifier (or A.F. section of radio set). The advantage of this "electrical" guitar manifests itself when used in large halls or rooms where one guitar (without amplification), would not be very loud. An ordinary microphone caused feedback, whereas the unit described here was used in conjunction with a 12-W. amplifier in a medium-size auditorium with not a trace of feedback or howl. The speaker was less than 10 ft. away. Very good quality was obtained.

FREEMAN R. TUPPER, JR.

WANTS ARTICLE ON A.C. HIGH-FIDELITY T.R.F. SET

Winnipeg, Canada:

I have been very interested in the 10-tube broadcast set described in the May, 1937 issue of *Radio-Craft*, particularly, because of the effort made in its design to improve fidelity of reproduction. I have lately built a 4-tube set, however (without, of course, the refinements included in this one), and now would wish to try something a little more sensitive and selective, with exceptionally good tone.

I am not just now interested in short-wave reception, as these last two mentioned together do not make sense, in my humble opinion. So I would like to see a constructional article on an A.C. high-fidelity T.R.F. set, 6 or 7 tubes, for the broadcast band only, with A.V.C., and with the tuning "eye" only if made necessary by the presence of A.V.C. If the description of such a set may appear in a near-future issue of *Radio-Craft*, I will almost certainly build it.

CYRIL G. PALMER

We'll do what we can. Meanwhile, check over back issues—except for the tuning "eye," we believe you'll find the Hi-Fi T.R.F. set! How about it, fellows?

WE CAN TAKE A HINT

Columbus, Ohio:

You asked for this, so here it is. I like fiction stories of a sort, so I buy certain fiction books. I like radio technical books, so I buy *Radio-Craft*. I have done so since January 1930 and still have every copy that I have bought. So my vote is: Do not expand in that direction; meaning, do not mix your subjects. If you have space to fill up, try putting in a page or two of technical terms, phrases and explanations. This is not a criticism. It's merely my own idea of what I want.

ORNSMA MEMBER

NEW—JUST OUT!

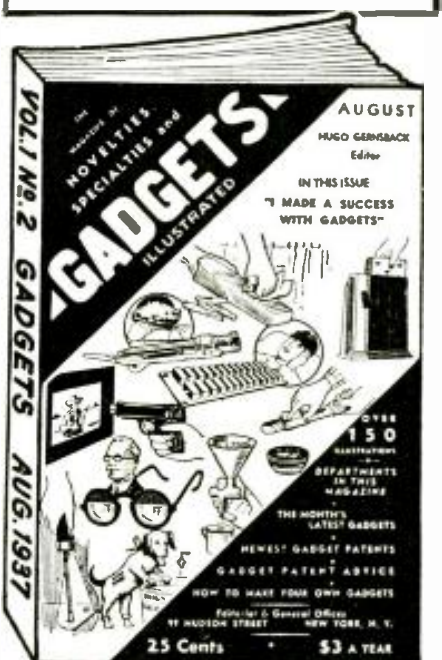

GADGETS AUGUST 1937
 VOL. No. 2
 HUGO GENSBACK Editor
 IN THIS ISSUE
 "I MADE A SUCCESS WITH GADGETS"
 150 ILLUSTRATIONS
 DEPARTMENTS IN THIS MAGAZINE
 THE MONTH'S LATEST GADGETS
 NEWEST GADGET PATENTS
 GADGET PATENT ABRIEVE
 HOW TO MAKE YOUR OWN GADGETS
 25 Cents \$3 A YEAR

The world's only magazine on this subject, contains 150 illustrations of the latest and best gadgets, novelties, and specialties. A veritable gold mine of information which you cannot get in any other way.

Every month, **GADGETS** ransacks not only America but the entire world for the newest, most useful articles of this type, including the latest gadget and novelty patents. Don't fail to read the article "I MADE A SUCCESS WITH GADGETS." Learn how inventors become rich in inventing or devising simple gadgets!

If your newsdealer cannot supply **GADGETS MAGAZINE** send 25c to

GADGETS Magazine
 99-R Hudson Street, New York, N. Y.

NEW!

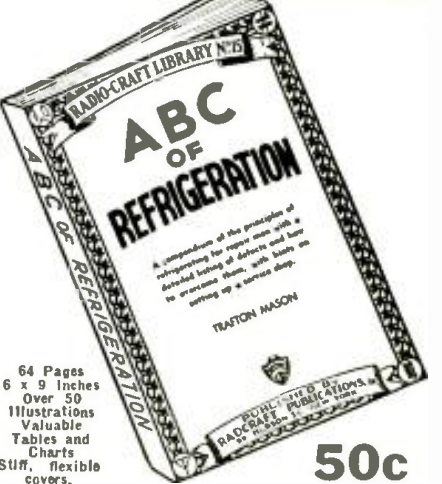

ABC OF REFRIGERATION
 A comprehensive of the principles of refrigeration for those who wish a detailed listing of factors and laws to working up a service shop.
 TRAFTON MASON
 64 Pages
 6 x 9 inches
 Over 50 Illustrations
 Valuable Tables and Charts
 SUFF. flexible covers.
50c

Trafton Mason, author of **ABC OF REFRIGERATION**, has written this book especially for those who are first becoming interested in the fertile field of Refrigeration Servicing. In this new volume you will find all the fundamental principles which underlie practical refrigeration systems in use today. While the contents of the **ABC OF REFRIGERATION** is somewhat elementary, a reading will still prove advantageous to experienced engineers since the author has included many valuable tabulations.

Brief Contents by Chapters
 Principles of Refrigeration * Parts of the Refrigeration System * Installation * Servicing Refrigeration Machines * Servicing Procedure * Service Hints * Glossary of Refrigeration Terms * Abbreviations and Symbols.

Send fifty cents in stamps, money order or coin for your copy of **ABC OF REFRIGERATION**—it is sent post-paid upon receipt of remittance.

RADCRAFT PUBLICATIONS, INC.
 99-R HUDSON STREET NEW YORK, N. Y.

Please Say That You Saw It in RADIO-CRAFT

NEW RADIO SETS FOR 1937-'38

(Continued from page 161)

NEW CROSLY "TELETUNE" FIVER

THE LATEST Crosley creation, as illustrated in Fig. G, provides a highly convenient and quick method of tuning in the popular stations. The "Teletune" permits one to swing quickly from one station to another with a single flip of the dial. Printed call letters are provided for quick insertion in the 10 openings provided in the escutcheon of the dial.

Other interesting features include dual band reception (540 to 1,720 kc.; 5,800 to 15,400 kc.); 5-in. electro-dynamic speaker; full-vision, edge-illuminated, 3-dimensional "mirro-dial" with graduations fused on the convex glass; pentode output tube; automatic volume control; power supply noise filter.

For a small set it has a healthy output of 2 W. The model illustrated is known as the Fiver Compact. The front of the cabinet is gracefully rounded and the side panels are made of highly figured walnut veneer. Measures 8 1/2 x 13 7/16 x 6 13/16 ins. deep. The circuit diagram of this receiver is illustrated in Fig. 2.

EMERSON "MIRACLE TONE CHAMBER"

6-TUBE A.C. SUPERHETERODYNE

ELIMINATING the old-fashioned "muffling" cloth of the speaker, the "miracle tone chamber" of this Emerson set, by a series of seasoned, grooved-louvre wood deflectors, causes a uniform distribution of sound waves of all frequencies. "It smoothes out the drastic harsh resonances and equalizes the flow of tone," states the manufacturer.

The set illustrated in Fig. II is the model AT-172. Other interesting features include complete automatic tuning of desired "key" stations; 3 tuning bands (American, Foreign and Police); 6 1/2-in. dynamic speaker; automatic volume control; and, tone control. The set utilizes a modern A.C. superheterodyne circuit employing 6 tubes. The cabinet is of hand-rubbed walnut, modernistically styled; measures 11 x 8 1/2 x 9 1/2 ins. deep.

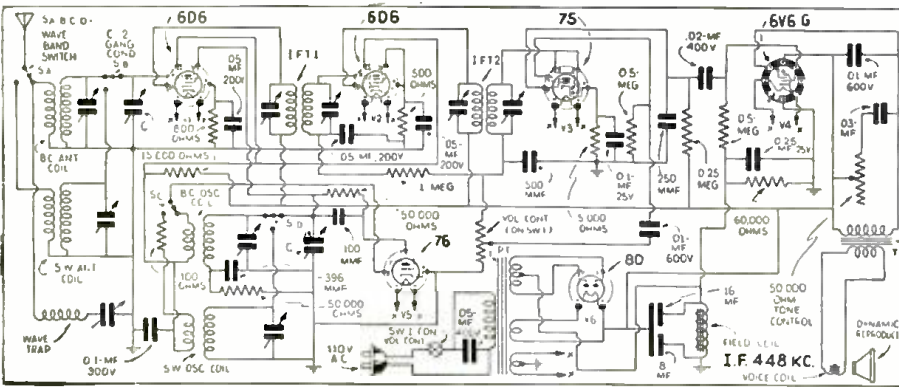

Fig. 4. Schematic diagram of the Kadette "Equaphonic" receiver model 649.

APPLICATION OF FEEDBACK TO A BEAM POWER AMPLIFIER

(Continued from page 184)

mixing. While this is not particularly new in the amplifier field, it has apparently been forgotten during the past few years. Two potentiometers are used for the separate inputs and are changed into a modified T pad construction through the use of a series resistor from the potentiometer tap to the control-grid of the first tube.

The volume controls of this amplifier are unusual in the fact that the calibrated etched plate reads directly in db. attenuation (see Fig. A). This is of considerable advantage in predetermining the gain setting if the output levels of microphones and pickups are known. Through the use of an 8-prong socket for the input plug, the input potentiometers can be connected to either the first or second stages. The gain can therefore be changed from 118 db. to 95 db., as desired.

Four stages are used in this amplifier, consisting of a 6J7 resistance-capacity coupled to a 6C5 transformer coupled to push-pull 6C5s, which in turn drive the 6L6s with a special input transformer. This input transformer incorporates a Varitone tone control permitting increase

of the high frequencies, low frequencies, or both high and low frequencies simultaneously. Some of the curves obtainable are illustrated in Fig. 6.

This article has been prepared from data supplied by courtesy of United Transformer Co.

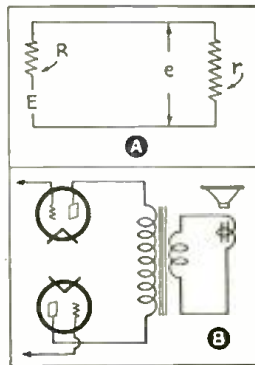
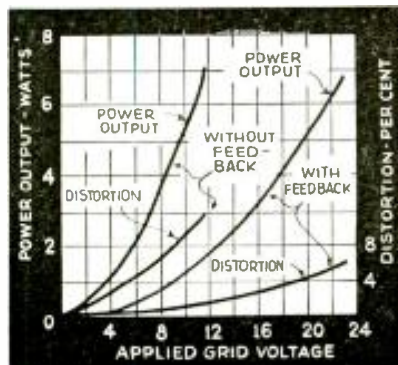
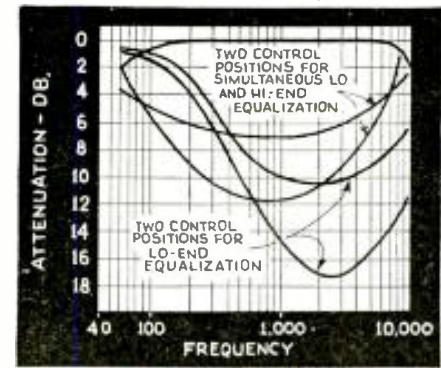
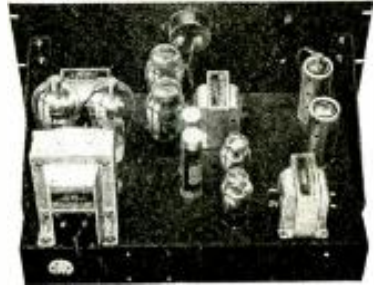

Fig. 6 (above). Several of the frequency curves obtained of the "Varitone" control.

Fig. 3 (extreme left). The percentage distortion vs. output of the 6L6 tube. Fig. 4 (left). Effective circuit of a speaker coupled to an output tube.

STANCOR TRANSFORMERS



FOR THIS 100 WATT MODULATOR \$12.21

THIS inexpensive but efficient modulator delivers 100 clean watts of audio with 800 volts on the plates of the modulator tubes. Built on standard Relay Rack and Panel.

TUBES: 6C6 Pre-amplifier; 76 voltage amplifier; Push-Pull 76's; 6A3 Drivers; TZ-20 Class B Modulators.

STANCOR TRANSFORMERS: Push-Pull Input, XA4206; Push-Pull Interstage, XA4208; Push-Pull Driver, XA4212; Output, XA2908.

FREE BLUEPRINT AND LAYOUT TEMPLATE

STANDARD TRANSFORMER CORPORATION 850 BLACKHAWK ST., CHICAGO

SHORT WAVE CONVERTERS FOR CAR RADIOS



Can be attached to any car radio. Has on and off switch and does not affect the reception on the standard broadcast band.

MODEL 600 covers 40-31.25-20-19 and 16 meter bands. Designed for American and Foreign short wave broadcast. Distance range 5000 to 10000 miles. List Price \$24.95

MODEL 300 Covers 8000 to 20000 kilocycles. Has variable condenser. List Price \$19.95

FOR USE BY POLICE AND OTHER OFFICERS OF THE LAW.

MODEL 200 with fixed condensers, covers 1000 to 2600 kilocycles. List Price \$11.95

MODEL 200 with variable condenser, covers 1550 to 6000 kilocycles. List Price \$17.95

MODEL 400 with fixed condenser, covers 5 to 10 meters. List Price \$13.95

MODEL 500 with variable condenser and illuminated dial. Very sensitive, has two metal tubes. Exceptional distance range. List Price \$21.95

Jobbers and Dealers wanted ABC RADIO LABORATORIES 3334 N. New Jersey St. Indianapolis, Indiana, U.S.A.



Earn While Learning at Home!

Television, Photo Electric Cells, Public Address

Many R-T-I Trained Men make up to \$75 a week and more in full-time radio jobs \$5-\$15 in spare-time alone. More trained men needed. Learn at home by quick, easy.

R-T-I WAY. Endorsed by 60 big concerns. Write for our Opportunity Book FREE. RADIO AND TELEVISION INSTITUTE, Inc., 2130 Lawrence Ave., Dept. 226, Chicago, Ill.

BE OUR AGENT!

BIG PROFITS FOR RADIO MEN

Sell our complete line of 16 MM and 35 MM motion picture equipment for theatres, institutions, clubs and home use. We have everything. Tremendous field; liberal profits. Write TODAY. S.O.S. CORP. 636-RA Eleventh Ave., N.Y.C. CABLE-SOSOUND, N.Y.

RADIOS WHOLESALE!

Buy direct. New line of ZEPHYR WORLD-WIDE all-electric, battery and auto radios, 5 to 15 tubes. All latest features. Buy at WHOLESALE PRICES. MONEY BACK GUARANTEE. Earn extra money with our Agent-User Plan. Write for FREE CATALOGUE.

30 DAYS TRIAL ZEPHYR RADIOD COMPANY 13141 Hamilton Ave. Detroit, Michigan



BRINGS YOU ANY ONE OF THESE 4 FAMOUS RADIO BOOKS

RADIO FANS! Help yourselves to a radio education for the price of 10c per book. These books give you a good foundation towards the study of radio. You'll be amazed at the wealth of information contained in them. They are especially written for beginners but are useful review and reference books for all.

Each book contains 32 pages, profusely illustrated with clear, self-explanatory diagrams. They contain over 15,000 words of clear legible type. They are an education in themselves and lay the groundwork for a complete study of radio and electricity.

HOW TO BUILD FOUR DOERLE SHORT-WAVE SETS

Due to a special arrangement with the publishers of SHORT WAVE CRAFT, we present in this book complete details for building the Doerle sets, also an excellent power pack if you plan to electrify any of the sets. Contains EVERYTHING that has ever been printed on these famous receivers. These are the famous sets that appeared in SHORT WAVE CRAFT: "A 2-Tube Receiver that Reaches the 12,500 Mile Mark," by Walter C. Doerle, "A 3-Tube 'Signal Gripper,'" by Walter C. Doerle, "The Doerle

HOW TO MAKE THE MOST POPULAR ALL-WAVE 1- AND 2-TUBE RECEIVERS

This book contains a number of excellent 1- and 2-tube sets, some of which have appeared in past issues of RADIO-CRAFT. These sets are not toys, but have been carefully engineered. They are not experiments. To mention only a few of the sets the following will give you an idea. The Megadyne 1-Tube Pentode Loudspeaker Set, by Hugo Gernsback—Electrifying The Megadyne—How to Make a 1-Tube Loudspeaker set, by W. J. Chesney—How to Make a Simple 1-Tube All-Wave Electric Set, by F. W. Harris—How to Build a Four-in-Two All-Wave Electric Set, by J. T. Bernsley, and others.

Each set is fully described in simple language so that anyone can build with limited means and with practically no experience a worthwhile all-wave radio set.

Has 30 illustrations. 10c postpaid

ALTERNATING CURRENT FOR BEGINNERS

This book gives the beginner a foothold in electricity and radio. Electric circuits are explained. This includes Ohm's Law, alternating current, sine waves, volts, amperes, watts, condensers, transformers, motors and generators, A.C. instruments, house-wiring systems, electrical appliances and electric lamps. Here are some of the Practical experiments which you can perform. Simple tests for differentiating between A.C. and D.C.; how to light a lamp by induction; making a simple electric horn; demagnetizing a watch; testing motor armatures; charging storage batteries from A.C. outlet; testing condensers with A.C.; making A.C. electromagnets; trying experiments on a cake of ice; making simple A.C. motors and many others. Has 42 illustrations.

10c postpaid

ALL ABOUT AERIALS

In simple, understandable language this book explains the theory underlying the various types of aerials; the inverted "L," the Doublet, the Doublet, etc. It explains how noise-free reception can be obtained, how low-impedance transmission lines work; why transposed lead-ins are used. It gives in detail the construction of aerials suitable for long-wave broadcast receivers, for



10c postpaid

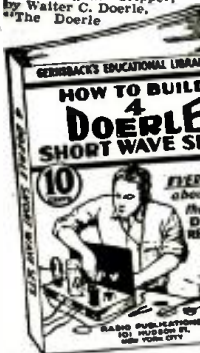

2-Tube: Adapted to A. C. Operation. "The Doerle 3-Tube 'Signal Gripper' Electrified," and "The Doerle Goes 'Band Spread.'" Has 30 illustrations. 10c postpaid



10c postpaid

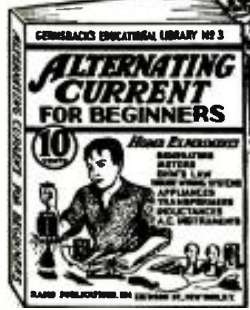

10c postpaid



10c postpaid

Remember that each book has 32 pages and contains over 15,000 words. Each book has from 30 to 66 fine illustrations. POSITIVELY THE GREATEST 10c VALUE IN RADIO BOOKS EVER OFFERED TO THE PUBLIC.

If you do not think that these books are worth the money asked for them, return them within 24 hours and your money will be instantly refunded.

Send for our FREE circular listing 48 new 10c Publications

RADIO PUBLICATIONS
99A Hudson St., New York, N. Y.

RADIO PUBLICATIONS
99A Hudson Street, New York, N. Y. RC937

Please send immediately POSTPAID the books checked:

- No. 1—How to Build 4 Doerle Short Wave Sets.....10c
- No. 2—How to Make the Most Popular All-Wave 1 and 2-Tube Receivers.....10c
- No. 3—Alternating Current for Beginners.....10c
- No. 4—All About Aerials.....10c

I am enclosing.....; the price of each book is 10c

Send me FREE circular listing 48 new 10c publications

Name

Address

City State

(U. S. Coin or U. S. Stamps acceptable.) Books are sent postpaid.

CLASSIFIED ADVERTISEMENTS

Advertisements in this section are inserted at the cost of twelve cents per word for each insertion—name, initials and address each count as one word. Cash should accompany all classified advertisements unless placed by a recognized advertising agency. No less than ten words are accepted. Advertising for the Oct., 1937, issue should be received not later than Saturday, August 7, 1937.

DOGS

TERRIERS: ALSO BULL DOGS, SHIP ANYWHERE.
Rob Tonn, Dallas, Texas.

BUILD IT YOURSELF

You can build this Trailer with ordinary tools easily from our step-by-step constructional sheets and large sized blueprints. Finest designed Trailer in existence. sleeps 4. Toilet. Shower. Electric Light, etc. Save 75% of the cost by building it yourself. Send 25c for plans sheet, illustrations and details.

THE PLAN SHOP, 910 Palmolive Bldg., Chicago, Ill.

BE SURE TO READ THE ANNOUNCEMENT WHICH APPEARS ON PAGE 190 OF THIS ISSUE

NEW TUBES FOR THE RADIO EXPERIMENTER

(Continued from page 146)

RECTIFIER

6WSG (Glass) Rectifier for Car-Radio Sets. This tube is interchangeable with the type 6X5 and 6X5G, where higher output is desired. The tube was designed primarily for service in car-radio receivers and may be used in either vibrator type or A.C. operated power supplies. See photo, Fig. A2. Its physical dimensions are given in Fig. 1.

Full-Wave Rectifier—Condenser- or Choke-Input Filter

Heater voltage (A.C. or D.C.)	6.3 V.
Heater current	0.9 A.
Max. A.C. voltage per plate (r.m.s.)	350 V.
Max. D.C. output current	100 ma.
Max. D.C. voltage between heater and cathode	500 V.

TUNING INDICATORS

6G5/6H5 Remote Cutoff Tuning Indicator. This is an improved type of tuning indicator interchangeable with the old 6G5. This tube affords "almost unbelievably better and more uniform illumination" with both high- and low-voltage supplies than its predecessor, states one manufacturer. The most noticeable improvement is that it maintains constant current throughout its normal life and has no tendency to "run away."

This tube is illustrated by photograph in Fig. A3. Its mechanical design is shown in Fig. 1. **6T5 Annular-Pattern Tuning Indicator.** Instead of "opening" like a fan, the "eye" of this new tube fills the area uniformly as shown in Fig. 1. This tube has operating conditions similar to those for the 250 V. rating of the type 6G5. This is illustrated by photograph in Fig. B.

The lighted portion covers only a very narrow region at the periphery of the target when no voltage is applied to the control-grid of the tube. When negative voltage is applied to the control-grid the width of the fluorescent ring increases until it covers practically all of the target. Changes in annular width, or diameter of the shaded section, are more readily detected than are changes in the shaded angular sector when the type 6G5 is employed.

In actual circuit use the varying negative voltage for controlling the shadow may be obtained from some point in the A.V.C. circuit, thus giving an indication of resonance when the unlighted portion of the target is at a minimum.

Type 6T5 is mounted in a T-9 bulb on a standard small 6-pin base. The tube is not designed for 100-volt operation.

Characteristics

Heater voltage A.C. or D.C.	6.3 V.
Heater current	0.3-A.

Operating Conditions and Characteristics

Heater voltage	6.3 V.
Plate supply voltage	250 V.
Target supply voltage	250 V.
Plate current (triode unit)*	0.24-ma., max.
Target current	3.0 ma., approx.
Control-grid voltage (triode unit)†	0.0 V.
Control-grid voltage (triode unit)‡	-22.0 V.
Triode plate resistor	1.0 Megohm

*With triode grid voltage of zero volts.
†For minimum illumination of target.
‡For maximum illumination of target.

SPECIAL SERVICE

2-RA-6 Mercury Rectifier Charger Bulb. This is the first in a new line of rectifier tubes being produced by a well-known manufacturer of electronic devices. The tube, illustrated in Fig. C, is interchangeable with other bulbs of the same rating, despite the fact that it incorporates many radical developments.

Chief among these is the new and different type of filament, of non-sagging construction, which has been designed along the lines of those used in industrial tubes where a life expectancy of 5,000 to 10,000 hours must be had; the life of the 2-RA-6 in practical service considerably exceeds its factory rating of 2,000 operating hours.

The universal type of cap connection permits the use of a fahnestock clip. Base connection is welded-on. Designed for use in battery chargers or any other device where rectified alternating current is desired.

(Continued on page 192)

Please Say That You Saw It in RADIO-CRAFT

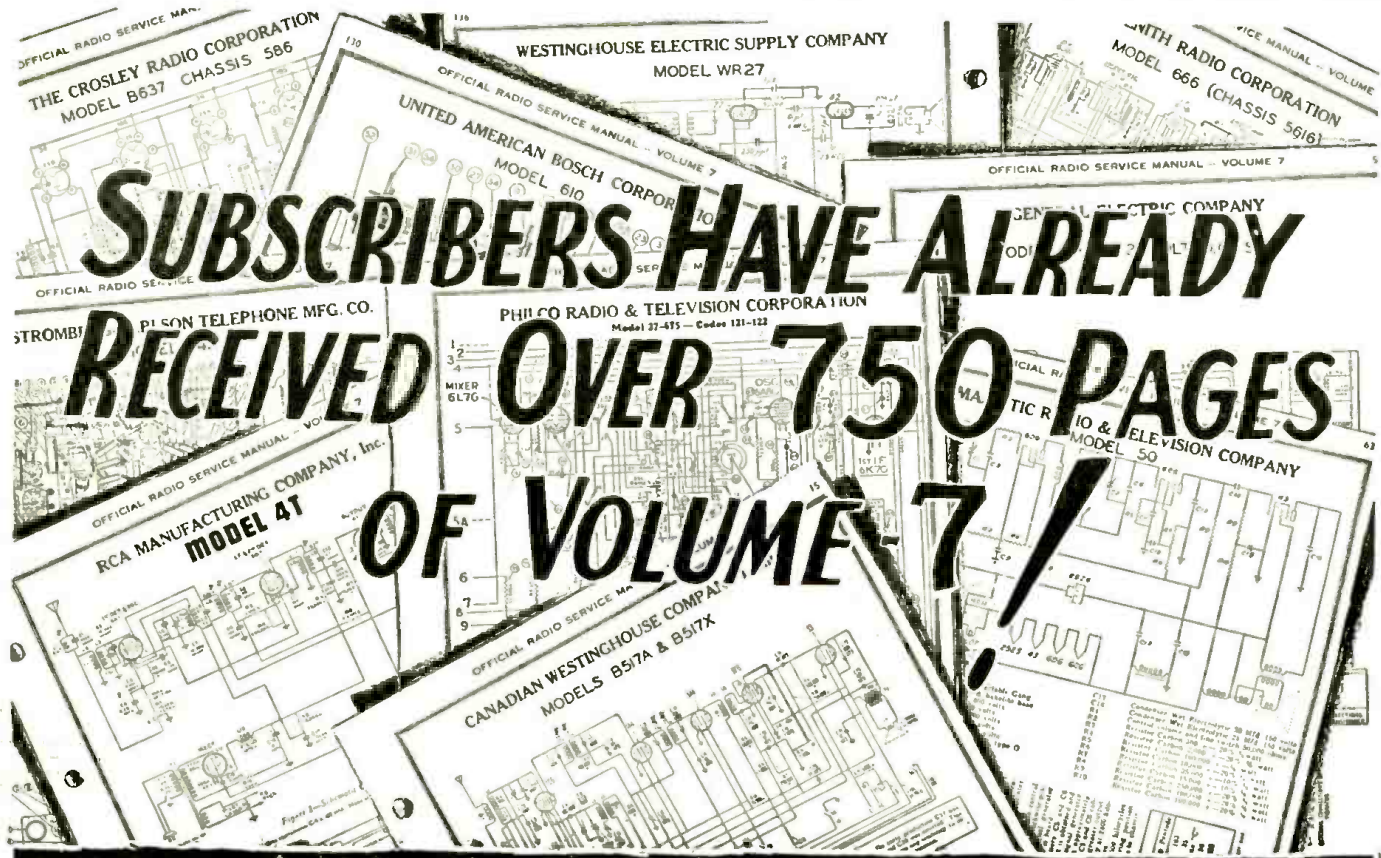

SUBSCRIBERS HAVE ALREADY RECEIVED OVER 750 PAGES OF VOLUME 7!

MR. DEALER AND SERVICE MAN—VOLUME 7 OF THE OFFICIAL RADIO SERVICE MANUAL IS NOW PUBLISHED IN MONTHLY INSTALLMENTS OF 150 PAGES!



THIS MANUAL WILL CONTAIN **OVER 1,800 PAGES**

Compare other service manuals with the new GERNSBACK OFFICIAL RADIO SERVICE MANUAL (Volume 7) as it is published today. You'll find the GERNSBACK MANUAL, by far more complete in service information—more up-to-the-minute with present-day receiver diagrams—and published entirely differently than in previous years. Most important of many innovations are the month-to-month installment method of publishing Volume 7—and the deferred payment plan which makes it convenient for every Service Man to own radio's greatest of service manuals. Write today for descriptive literature which gives complete information about Volume 7 of the OFFICIAL RADIO SERVICE MANUAL—and the plan which tells how to pay-as-you-compile your Manual. Mail the coupon below—**TODAY!**

RADCRAFT PUBLICATIONS, Inc., 99 Hudson Street, NEW YORK, N. Y.

RADCRAFT PUBLICATIONS, Inc. RC-937
 99 Hudson Street, New York, N. Y.

Gentlemen: Please send me descriptive literature on Volume 7 of the GERNSBACK OFFICIAL RADIO SERVICE MANUAL—and details for buying this edition on the deferred payment plan.

Name

Address

City State

Please Say That You Saw It in RADIO-CRAFT

OPERATING NOTES

(Continued from page 153)

was put in and reception then was excellent.
BURDETTE MANNING

Air-King Model 52. This set had a bad case of intermittent reception, the cause of which could not be readily located. So, after many hours of work, the trouble was found to be an open-circuit in the primary of the oscillator coil and also an open-circuit in the primary of the last I.F. transformer. Replacing of these coils and reneutralizing, caused the set to play as good as new.

JAMES C. CUMMINGS, JR.

B.O.P.-Buick, Oldsmobile, Pontiac, or Air Mate Model 65. Had difficulty locating some trouble in a "dead" Buick, Oldsmobile, or Pontiac auto-radio set. Hitting the set would start it into operation. Shut off and turned on set; dead again.

The cause was supposed to be a loose connection; yet, upon taking the set apart and testing it, everything seemed all right.

The cause eventually was found to lie in a faulty vibrator. After taking the vibrator out of can, the set worked perfectly; upon replacing the vibrator in its can and remounting the set, the trouble repeated. The vibrator was repaired and adjusted, and tested all right. It worked perfectly out of the receiver can case but not in the set. Replaced vibrator with new one and trouble was over entirely. This condition is quite common in this model as well as other models. It may be well to state that the manufacturers always recommend new vibrators—this is a point to remember.

Elaborate precautions are taken to prevent any introduction of foreign matter such as dirt or lint into the vibrator. Particles of dust, too small for the naked eye to see, usually cause serious trouble, such as above stated. One of the most important questions that arises is "Why the cellophane wrapper?" There is your answer! Not all manufacturers wrap their vibrators in cellophane. Only the wise ones do. Furthermore, as there is virtually no tolerance allowed in the distance between the points on the vibrator reed and those of the spring arms when the vibrator is in a natural position, one can just picture what the introduction of foreign matter will do to a vibrator. It may also be well to state that 90 per cent of auto-radio trouble is caused by repaired vibrators which are not properly sealed, or those that have seen their useful life, which is 1,000 hours or better.

Service Men who service vibrators should take considerable precautions in handling, just as anyone would take in handling his watch, in that he would not think of removing the case to let the dust or foreign matter get into the watch and ruin it entirely.

GEORGE F. BAPTISTE

Sparton 111-A. I recently serviced a "dead" Sparton 111-A, which I found had no plate voltage. A continuity check between the filament of the type 81 tube and ground showed a direct short. Figured job as a "filter-condenser" and carried chassis to shop. On checking filters, I found them OK. After several hours of checking, I found the trouble in the external choke socket.

This job had a choke fastened to the side of the cabinet which plugs into a socket on the side of the pack. This socket is assembled with 2 rivets through a metal strap. When plug is inserted, the springclips are spread and come very close to the rivets, causing a short to ground.

Cut off end of socket springs nearest to rivet, clean off burned metal, and re-assemble socket. Set will now be OK.

K. R. HALL

Victor Micro-Synchronous Model RE57. When working on the Victor Micro-Synchronous model RE57, if a "ground" should appear when the set is placed right-side up, and disappear when placed in the up-side-down position, remove the detector transformer shield can cover and look inside. It will be found that the primary, placed horizontally within the secondary, is held in place by a small brass shaft. The primary becomes loose on this shaft and, in the right-side-up position, drops down and makes contact with the "live terminal." To cure this, slip a piece

of "fish-paper" between the shaft and the live terminal. The "ground" will disappear and the set will be restored to normal operation. (The detector transformer is the first large one on the left, looking in from the rear.)

JAMES G. HORSFORD,
Santurce, Puerto Rico.

Crosley 122. When the volume control was turned on full, the output was distorted. I tested the tubes and various components of the A.F. amplifier. These were found to be OK. The trouble was found in a faulty 1,300-ohm wire-wound candohm resistor. This resistor supplies plate and screen-grid voltages for several tubes.

Crosley 168. The complaint on several sets of this model has been "hissing noise" on all stations and lack of automatic volume control. In every case the trouble was remedied by replacing the dual 8-mf. 25 V. condenser used in the cathode circuit of the 2nd-detector and output tubes, with 75-V. units.

RCA Victor R4. Circuit oscillation in this model when all voltages are normal and tubes test "good," can, in most cases, be traced to an open 8-mf. electrolytic condenser (C-16 on RCA Service Notes). This condenser is in a can with several other condensers. An 8-mf. 500 V. electrolytic will fit very nicely under the chassis.
C. MCCLINTOCK

Majestic 90. A call on this model gave an interesting job of fading. Upon arriving at the customer's home, I was told that the set would gradually fade out and then come back with a snap. I brought the set to the shop and found two leaky 0.5-mf. condensers (these condensers bypass the R.F. plate supply). Resistance checking found an abnormally high resistance in the detector plate supply choke or resistor. Some sets have a 2,000-ohm choke and others, made later, have a 35,000-ohm resistor. This choke would open up and the filter would gradually unload; after about 10 sec., the choke would close.

The choke is located in the condenser back of the power pack. One lead is connected internally to the junction of the second choke and the speaker field. The other is brought out to a separate lug. When a resistor was substituted, a slight increase in hum was noticed, so a choke was put in the space below the socket of the type 80 tube.

L. L. BROWN, JR.

Majestic 300-300A. We had this set in for repair. The complaint was A.C. hum. After some checking, we found that the hum gradually diminished as the tone control was turned to the "bass" side. In this model, the volume control, mounted on the side of the cabinet, was entirely separate from the chassis, with the A.C. switch on the back of the tone control and the switch leads cabled with those of the control. The remedy is to separate these leads, twist those of the tone control, and tape the 2 pairs together. This kills the hum by destroying the inductive effect.

IVAN L. STRAWSER

SERVICING QUESTIONS & ANSWERS

(Continued from page 153)

(24) Fred Gallo, New York City: [Q.] My Fada model 211 A.C.-D.C. set recently went "dead". I checked all the metal tubes in a tube tester and found them perfect. Please let me know what can be the trouble.

[A.] An "open" ballast resistor (which looks like a metal tube) is undoubtedly the reason for this set going dead. Fig. Q.24. The 190-ohm resistor (marked "X" in diagram) is generally the first to burn out. Be sure when replacing this ballast "tube" to get one with the same ohmic resistance as the original, otherwise the tubes may get either too little or too much heater voltage.

TERRIFIC HOWLING

(25) Roland Gernz, Albany, New York: (Continued on page 192)

METALEX EXPONENTIAL HORNS
A Boon To The Sound Engineer



Model 2800

- Steel for Wear
- "Ex" for Objectionable Resonances

These efficient exponential horns should not be confused with the so-called parabolic units.

Spun from steel and coated with the material "Ex" which eliminates all objectionable resonances, they give the finest type of reproduction and almost unlimited wear. Stocked in 3 different sizes.

Write for literature on these horn innovations.

Wright-DeCoster Distributors are always anxious to cooperate.

WRIGHT-DECOSTER, INC.

2251 University Ave., St. Paul, Minn.
Export Dept.: M. Simons & Son Co., New York.
Cable Address: "Simontrics"
Canadian Representatives:
Wm. F. Kelly Co., 1207 Bay St., Toronto, Ont.
Taylor & Pearson, Ltd., Edmonton, Alt.

Over 12,000 RADIO PARTS...
RADOLEK'S SERVICE IS FASTER
At Your fingertips!

THE NEWEST BOOK IN RADIO

The Radolek 1937 Radio Profit Guide is the most complete Radio Parts Book ever published. Includes new merchandise shown during the June Radio Show (over 12,000 parts)—the right replacement item for every radio that you will service—Test Instruments, P.A. equipment Home and Auto radios, Books, Tools, etc.

RADOLEK'S SERVICE IS FASTER
There's no Sit-Down, Lay-Down, or Slow-Down at Radolek—our organization gives you what you want when you want it—and at the Right Prices.

AUTO RADIO HEADQUARTERS
Everything in Auto Radio—Universal control heads, Dash mounting adapter kits, Auto aerials, Cables, and Vibrators. Send for your FREE Profit Guide NOW!

RADOLEK

601 W. Randolph, Chicago, Dept. C-9

Send me the Radolek Radio Profit Guide FREE

Name

Address

Service man? Dealer? Experimenter?

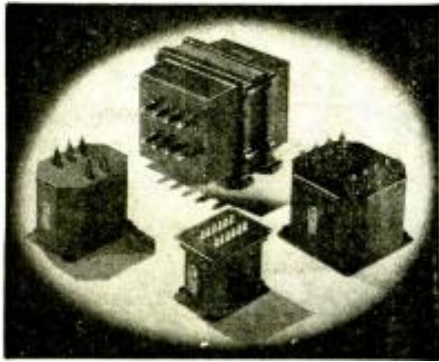

UTC VARIMATCH Modulation Transformers will match ANY Modulator Tubes to ANY RF Load . . .

VM-0	Maximum audio output 20 watts. Net	\$ 3.00
VM-1	Maximum audio output 30 watts. Net	4.80
VM-2	Maximum audio output 60 watts. Net	7.50
VM-3	Maximum audio output 125 watts. Net	12.00
VM-4	Maximum audio output 300 watts. Net	19.50
VM-5	Maximum audio output 600 watts. Net	42.00

Varimatch Never Becomes Obsolete

See your local jobber for the new UTC Varimatch Bulletin and the new PS-401 catalog listing the most complete line of radio transformers in the world.

UNITED

TRANSFORMER CORPORATION
72 SPRING STREET NEW YORK, N.Y.

SHALLCROSS AKRA-OHM RESISTORS

Shallcross wire wound resistors are especially adapted for:

- Voltmeter Multipliers
- Shunts
- Electrical Equipment
- Telephone Equipment
- Attenuators
- Fading Controls

Bridges for measuring Resistance, Capacity and Inductance

- Resistance Amplifiers
- Burglar Alarm Equip.
- Broadcasting Station Eq.
- Fire Alarm Equipment
- Television Equipment



Type 100



Type 190

AKRA-OHM Resistors are manufactured in any value from 0.01 ohms to 10 megohms to any accuracy from 0.1% to 1%.

Send 6c in stamps and the name of your supplier and we will send you Bulletin 121-P giving electrical and mechanical specifications of the Shallcross resistors, and Bulletin 90-P showing the new resistance, voltage, current, power charts.

SHALLCROSS MFG. CO., Collingdale, Pa.

NEW TUBES FOR THE RADIO EXPERIMENTER

(Continued from page 188)

Characteristics

Filament voltage	2 V.
Filament current	13 A.
Output	6 A.
Inverse peak voltage	300 V.

WL-461 Ultra-H.F. Therapy and Radio Oscillator-Amplifier. Some of the main fields of application in which this new tube will be used, due to its unique characteristics, are for therapy, radio, and such other purposes as may require an ultra-high frequency oscillator and amplifier. See Fig. D.

In therapy work, in particular, it will permit higher power output to be obtained at the shorter wave lengths than has heretofore been conveniently possible. It can be used equally well in ultra-high frequency radio transmitters, wherever a 3-element radio frequency amplifying tube of its characteristics is required.

The usual types of tube construction have been modified in this distinctly modern power tube by supporting the control-grid, filament and plate electrodes directly from short, heavy rods. These support rods in turn terminate in short, sturdy thimbles which may be used to connect directly with the external circuits. This tube is one of the first on which such basing has been used, although it has been used for many years on high-watt airport flood lamps where the high current carrying ability has been conclusively demonstrated.

Other decided advantages are the low inter-electrode capacity of the tube which results from the new mounting and the high conductivity of the large and short support rods. Tantalum is utilized for the anode material in this tube which from previous experience has proven superior for tubes designed for high-frequency operation. This tube has a plate dissipation of 160 W. and is capable of delivering 400 W. of useful power up to 50 megacycles.

The simplification of the internal supporting structure has also made it possible to reduce the size of the tube to the point where only a minimum amount of space need be reserved for it.

Ratings

Max. D.C. plate voltage	2,000 V.
Max. A.C. plate voltage	2,500 V.
Max. plate current	250 ma.
Filament voltage	5 V.
Filament current	11.5 A.

SERVICING QUESTIONS AND ANSWERS

(Continued from page 191)

[Q.] On some of the more powerful stations I am troubled with a terrific howling noise which invariably spoils good programs. All my tubes were tested and found to be perfect. What can I do to overcome this trouble? The make of my set is a Grunow model 1191.

[A.] In all probability your trouble lies in a 6C5 audio tube becoming microphonic due to the handling of a large signal. (Even though, on most testers, the tubes tested "perfect.") It is advisable in such a case to interchange the two 6C5s until the set operates to your satisfaction. Sometimes, however, both of the 6C5s may be susceptible to microphonic noises, whereupon a new tube will be necessary.

RADIO DISTRIBUTOR ADOPTS TIME PAYMENT PLAN

The Wholesale Radio Service Company has recently announced its new deferred payment plan which requires a small down payment and a choice of monthly installments covering 6, 9 or 12 months. The plan is extremely liberal and should prove of material benefit to radio men of moderate means.

In addition, and of special interest to "hams" is the company's new "trade-in" plan on amateur transmitting equipment. Other companies will soon follow suit—or will they?

ADVERTISERS' INDEX

A	
ABC Radio Laboratories	187
Aladdin Radio Industries	181
Allied Radio Corporation	151
American Technical Society	180
Amperite Corporation	176
Amplifier Company of America	183
Amplitone Products Company	181
Arrow Sales Company	189
B	
The Brush Development Company	182
C	
Central Radio Laboratories	174
Cinematograph Corporation	185
Classified Section	188
Cornell-Duhalier Corp.	181
Cornish Wire Company	182
Coyne Electrical School	168
E	
Electric Institute	172
G	
G & G Genuine Majestic Refrigerator and Radio Parts Service	189
Gadgets Magazine	186
Goldentone Radio Company	189
Grenpark Company	181
H	
Hammarlund Mfg. Company	185
Hygrade Sylvania Corp.	179
K	
Kenyon Transformer Co., Inc.	177
L	
L & L Electric Company	178
Lanaster, Albwin & Rommel	182
Lincoln Engineering School	185
M	
Metal Cast Products Company	178
Midwest Radio Corp.	Inside Back Cover
The Muter Company	170
N	
National Carbon Company	Back Cover
National Radio Institute	129
National Schools	180
National Union Radio Corp.	167
New York YAIKA Schools	182
P	
The Plan Shop	188
Post Radio Corp.	167
Preston Apparatus Corp.	181
R	
RCA Institute, Inc.	176
RCA Manufacturing Co., Inc.	185
Radio & Technical Pub. Co.	182, 183
Radio & Television Institute	187
Radio Circular Company	171
Radio City Products Co.	181
Radio Publications Co.	188
Radio Service Institute	178
Radio Training Association	189
Radiolok Company	191
Raschon Production Corp.	171
Reedrite Meter Works	177
Remington Rand, Inc.	180
John F. Rider	189
S	
S. O. S. Corporation	187
Shallcross Mfg. Company	182
S-Star Mfg. Company	182
Standard Transformer Corp.	187
Supreme Instruments Corp.	Inside Front Cover
Star Hat Power Devices Co.	178
T	
Tavella Sales Company	178
Telebix Company	180
William A. Thomas Co.	176
Triplet Electrical Instrument Co.	169
Tung Sol Lamps Works, Inc.	175
U	
United Transformer Corp.	192
Universal Microphone Co.	185
W	
Welworth Trading Company	176, 186
Weston Electrical Instrument Corp.	173
Wholesale Radio Service Co., Inc.	189
Wright-DeCoster, Inc.	191
Z	
Zenith Radio Company	187

(While every precaution is taken to insure accuracy, we cannot guarantee against the possibility of an occasional change or omission in the preparation of this index.)

Please Say That You Saw It in RADIO-CRAFT

LATEST 20-TUBE MIDWEST TUNES ITSELF BY ELECTRIC MOTOR..... JUST TOUCH A BUTTON!

ONLY MIDWEST'S DIRECT-FROM-FACTORY POLICY MAKES THIS AND OTHER SENSATIONAL FEATURES POSSIBLE AT AMAZINGLY LOW PRICES!

SAVE UP TO 50% DIRECT FROM MIDWEST FACTORY



20 TUBES
6 BANDS
SUPER POWERED
TO BRING IN WEAK OVERSEAS STATIONS

A VITAL

engineering advancement,

Midwest's Electric Touch-Button Tuning is entirely automatic and the sensation of the radio world! Ten touch buttons completely control the set. Touching any button turns set "on" and tunes in desired station. Nine other favorite stations are automatically and perfectly brought in... Zip... Zip... Zip... as fast as you can touch buttons. No more dial twiddling!

Why be content with an ordinary 10, 12 or 14-tube set, when you can buy a 20-tube Super Deluxe Motorized Midwest for the same money. It will surprise and delight you with its brilliant world-wide reception on 6 bands. You save 50%—and get 30 days free trial in your own home—when you buy direct from the factory at wholesale prices. You are triply protected with Foreign Reception Guarantee, One-Year Warranty and Money-Back Guarantees.

TERMS AS LOW AS \$1.00 A WEEK

You have a whole year to pay for your Midwest on the easiest and most convenient of credit terms. Send for the FREE 40-page catalog today—and begin to enjoy motorized radio at its best, right now!

Send for **FREE 40-PAGE CATALOG!**

See for yourself that Midwest offers today's greatest radio values! Write for new 1938 Factory-To-You Catalog showing 40 pages of radios, chassis and features—in their natural colors. Select the one you like on 30 days FREE TRIAL in your own home.

Service Men! Join nation-wide Midwest service organization. Write for free details.



MAGIC MOVIE DIAL

Now, Midwest gives you today's finest world-wide overseas reception. Note that the dial on the chassis shows only the broadcast band. Then, flip 6-wave-band switch, and, instantly, 6 additional bands are projected on the dial.

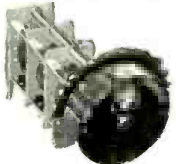

MAGIC MYSTIC BRAIN

"Mystic Brain" interprets your touch button signals and controls electric motor. Ten contact fingers can be easily set to any ten stations you desire.

only \$**49**⁹⁵

FACTORY-TO-YOU NEW LOW BASE PRICE CHASSIS

The new 1938 Midwest consoles are triumphs of the furniture art. The Trio-Sonic Reproducers (5 speakers), installed in this 20-tube console were especially developed for use with Double Power Beam Output Tubes.



30 DAYS FREE TRIAL

PASTE COUPON ON 1¢ POSTCARD...OR WRITE TODAY.

MIDWEST RADIO CORPORATION
Dept. BB-12, Cincinnati, O.
Send me your new FREE catalog and complete details of your liberal 30-day FREE trial offer.
(Special offer and prices prevail only when dealing direct with factory by mail.)

Name

Address

Town State

User-Agents Make Easy Extra Money. Check Here for details Check Here for 24-page BATTERY catalog

MIDWEST RADIO CORP.
DEPT. BB-12 CINCINNATI, OHIO, U.S.A.
Established 1920 Cable Address MIRACO... All Codes

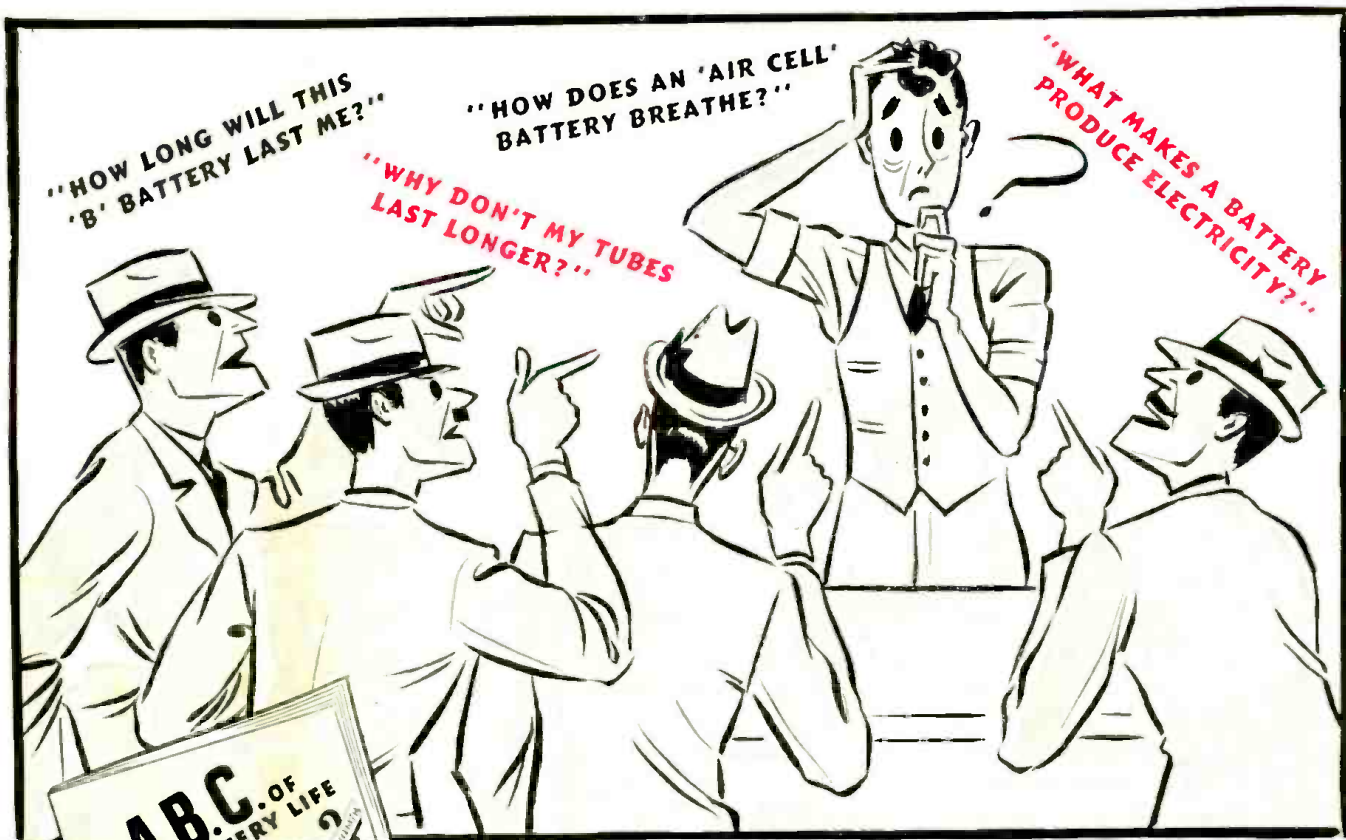

HERE'S A BOOK WITH ALL THE ANSWERS!

Answers all your customers' questions about batteries. 24 big pages—printed in color—completely illustrated

Every radio dealer should have a copy of this new book. It answers simply and accurately—the many questions about batteries and battery life that your customers are always asking. With it on the counter you can tell them in a minute just what they want to know . . . and show them the proof of your statements. This isn't just advertising matter. It covers the field. Each subject is completely illustrated with charts, cut-away sections of batteries, and hook-ups. You *need* a book like this . . . and this one is *yours*—FREE! Just send us the coupon at the bottom of this page and we'll get your book off to you by return mail.

—AND IT'S FREE!

Send this coupon for your free copy of this valuable book.

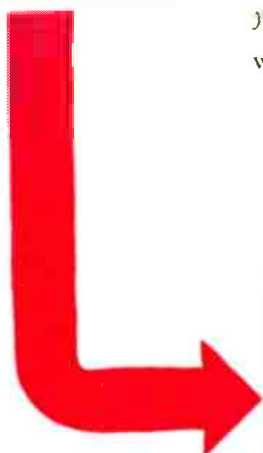

NATIONAL CARBON COMPANY, INC.

General Offices: New York, N. Y. • Branches: Chicago, San Francisco
Unit of Union Carbide **UCC** and Carbon Corporation

The words "Air Cell" are a trade-mark of National Carbon Company, Inc.

NATIONAL CARBON COMPANY, INC.,
P. O. Box No. 600, Grand Central Station, New York, N. Y.
Please send me a free copy of the new illustrated book, "The A B C of Radio Battery Life."

Name _____

Address _____

R.C.-5